

**FOOD AND AGRICULTURE ORGANIZATION  
OF THE UNITED NATIONS**



**CARIBBEAN TECHNICAL COOPERATION NETWORK IN  
ARTISANAL FISHERIES AND AQUACULTURE**

**THE CONSTRUCTION AND DEPLOYMENT OF  
DEEP WATER FISH AGGREGATING DEVICES  
IN THE ISLAND OF CURAÇAO**

**PES-25**

**FAO REGIONAL OFFICE FOR LATIN AMERICA AND THE CARIBBEAN**

**Santiago, Chile  
1995**



FOOD AND AGRICULTURE ORGANIZATION  
OF THE UNITED NATIONS

CARIBBEAN TECHNICAL COOPERATION NETWORK IN  
ARTISANAL FISHERIES AND AQUACULTURE

**THE CONSTRUCTION AND DEPLOYMENT  
OF DEEP WATER FISH AGGREGATING DEVICES  
IN THE ISLAND OF CURAÇAO**

GERARD VAN BUURT  
Department of Agriculture, Animal Husbandry and Fisheries,  
Curaçao

RLAC/95/14-PES-25

FAO REGIONAL OFFICE FOR LATIN AMERICA AND THE CARIBBEAN

Santiago, Chile  
1995



## FOREWORD

It has long been known that drifting objects, such as logs and branches, attract and keep fish gathered around them. Knowledge of this behaviour of fish has been used for a long time by traditional fishermen, particularly in South East Asia and the western Pacific. In the Caribbean, palm fronds, sugarcane tops, old netting and branches have been used as fish aggregating devices (FADs) for flying fish.

Fishermen often spend lots of time and fuel looking for fish, especially pelagic species. FADs help fishermen to save time and money while looking for fish because fish are attracted to the FADs and stay around them. Despite their value in this respect, FADs pose a number of problems in their deployment and utilization. Design factors need to be optimized in terms of construction, deployment, economy and durability. These and the practical difficulties presented by the variety of local sea conditions existing in the Caribbean must be taken into account in planning the deployment of FADs.

This publication on the construction and deployment of deepwater fish aggregating devices in the island of Curaçao attempts to provide insights gained by the Department of Agriculture, Animal Husbandry and Fisheries of Curaçao into some of these problems. It is published by the FAO Regional Office for Latin America and the Caribbean within the framework of the Caribbean Technical Cooperation Network in Artisanal Fisheries and Aquaculture. One of the main objectives of the Network, which is based on the principles of Technical Cooperation Among Developing Countries (TCDC), is to promote technical cooperation and exchange among the countries of the region.

Interest in commercially viable methods to aggregate fish is growing in the region. For this reason, the FAO Regional Office for Latin America and the Caribbean would like to share the experiences of Curaçao with the rest of the countries of the region.

Severino de Melo Araujo  
Assistant Director-General  
Regional Representative for Latin America and the Caribbean

## PREPARATION OF THIS DOCUMENT

This document is based on the experiences of the Department of Agriculture and Fisheries of Curaçao in the design, construction and deployment of three deepwater Fish Attraction Devices (FADs). It was prepared by Mr. Gerard van Buurt of the Department of Agriculture, Animal Husbandry and Fisheries.

In view of the interest in insular Caribbean countries in harvesting the large pelagic species that migrate through the region, and considering that the experiences of Curaçao in the use of FADs should be of value to the countries of the region, the FAO Regional Office for Latin America and the Caribbean decided to publish this document as part of its PES series to allow for widespread diffusion in the region.

The document is published within the framework of the Caribbean Technical Cooperation Network in Artisanal Fisheries and Aquaculture which is based on the concept of technical cooperation among developing countries (TCDC).

The author has expressed his wish to receive comments and suggestions which should help him to improve his work on deepwater FADs. He can be contacted at the Department of Agriculture, Animal Husbandry and Fisheries (Dienst Landbouw, Veeteelt en Visserij), Klein Kwartier 33, Curaçao, Netherlands Antilles. Fax: 599 9 370723; Tel: 599 9 376170.

The bibliographical references have been presented as submitted by the author.



## **ABSTRACT**

Three deepwater fish aggregating devices (FADs) were built, two of which have been deployed along the South coast of Curaçao. The objective of the program is to develop durable FADs which could be anchored at various sites along the coast of Curaçao on a permanent basis. The effectiveness of these FADs and their usefulness to the local fleet of trolling vessels were evaluated. A Simrad EA300P portable precision echo-sounder with a 49KHz transducer was used. The buoys are made of GRP materials and have a spar buoy design. In this report, design considerations, construction details and deployment methods which may be of use to others are emphasized.

## **ACKNOWLEDGEMENTS**

The author is indebted to a number of agencies and colleagues for their assistance and useful comments for the duration of the project.

The buoys, mooring lines and attractors were financed by the Dutch Government through KABNAA, the Dutch Development Agency for the Netherlands Antilles and Aruba. The echo-sounder, anchors, anchor ramp, buoy ramp and all other expenses were financed by the Island Government of Curaçao. The buoys were built, according to L.V.V. specifications by Mr. Frank Ballentina of the Marine Coastmaster Co. The anchor ramp was designed by Mr. M.F. Leito and Mr. Son Constanca. Captain Ferro, Captain Bart Schoonen and their crews kindly assisted to deploy the buoys with their vessels *Klara* and *Mermaid*. The Curaçao Seaquarium and the CITRO (Citizens Rescue Organisation) assisted with the inspection, replacement and maintenance of the buoys. Mr. Paul Schotborg rebuilt buoy no. 3. Sydney M. Joubert corrected the "Resumen en Español." Jacinto (Tico) Ras, Ron Martis and Murray Joubert Jr. assisted in converting the construction drawings to a computerised format (Coreldraw 3.0).



## *RESUMEN EN ESPAÑOL*

Experiencias obtenidas con dispositivos para la agregación de peces (DAP) que fueron anclados en aguas profundas alrededor de la Isla de Curaçao en el Mar Caribe.

En Curaçao y también en la isla adyacente, Bonaire, existe una pesca artesanal desarrollada. La plataforma costera de estas islas es muy estrecha y este factor limita mucho las capturas de especies demersales. Por eso la pesca artesanal se dedica principalmente a la captura de especies pelágicas que constituyen más del 80% del desembarque total. Pequeñas embarcaciones pesqueras de entre 5 y 10 metros de largura, propulsadas por motores Diesel de dentro del casco, salen al mar diariamente para pescar con curricán. Con una flota pesquera pelágica y el mercado para sus productos ya existentes, parece lógico introducir atrayentes para peces pelágicos, con el propósito de incrementar y mejorar la eficiencia de la captura de estas especies.

El objetivo principal del proyecto es el desarrollo de una boya de atracción duradera que sea económica y que se pueda anclar permanentemente en varios sitios en mar profundo alrededor de la isla. El diseño se basa en las experiencias con atractores en mar profundo en el Océano Pacífico. La idea es que una boya más duradera, aunque más costosa, a la larga será más económica que los diseños más simples y menos costosos que no perduran. En el Pacífico este propósito fue frustrado por la frecuente ocurrencia de tormentas tropicales (tifones), que hasta los mejores diseños muchas veces no aguantaron. Curaçao está situado en el límite sur del paso de los huracanes, los cuales, por consiguiente, raras veces pasan por la isla. Es posible que en esta isla y tal vez también en otras regiones tropicales con poca ocurrencia de tormenta tropical resulte factible el uso de atractores perdurables.

Se sabe que es técnicamente factible construir boyas perdurables para aguas profundas. Existen boyas con fines militares, que fueron colocadas en aguas muy profundas y que perduraron durante muchos años. Sin embargo en estas boyas el costo no fue considerado de importancia. En las boyas para la pesca es necesario obtener un balance razonable entre el costo y la perdurabilidad de una parte y el rendimiento de la otra parte.

La boya en la superficie fue construida con tubería HOBAS-DUROTEC y otros materiales de fibra de vidrio. Estos tubos consisten de materiales de fibra de vidrio mezclados con arena de cuarzo. La boya está equipada con una luz y un reflector de radar montados sobre un mástil central. En una boya cilíndrica delgada es fácil montar la luz y el reflector a algunos metros sobre el nivel del mar, factor que incrementa mucho la visibilidad. También este tipo de boya, cuando está correctamente balanceada, con peso de lastre interno y externo (cadena galvanizada), se mueve muy tranquilamente con las olas, sin batir. En este aspecto es superior a las boyas de diseño cilíndrico aplanado, como, por ejemplo, ciertas boyas construidas de llantas. El sistema de anclaje lo constituye una catenaria invertida, que utiliza cuerda de polipropilena con un diámetro de



20 mm. El ancla es una caja de hierro rellena de hormigón. Los atractores sumergidos debajo de la boya en la superficie son del diseño MacIntosh.

Para posicionar los atractores en agua con una profundidad de entre 750 y 1100 metros fue necesario utilizar una ecosonda adecuada para el uso en aguas profundas. Se utilizó la ecosonda Simrad EA 300 P, que es una ecosonda portátil de precisión, con transductor de 49 KHz y ángulo de 11 grados; esta ecosonda está capacitada para medir con bastante precisión profundidades hasta los 1500 m. Sin embargo es necesario calibrar la ecosonda por el cambio de la velocidad del sonido en el agua del mar. Esta velocidad es función de la temperatura, la salinidad y la presión. Una curva de calibración fue establecida para indicar la relación entre la profundidad y la velocidad del sonido en las aguas del mar alrededor de Curaçao. Esta curva se basa en datos oceanográficos obtenidos del banco de datos NODC del Instituto Scripps, la Jolla, California.

A base de las experiencias obtenidas (descritas detalladamente en el artículo) resulta importante mencionar en este resumen el uso del ánodo sacrificial. Tal ánodo daba muy buena protección a los tornillos, los conectores y el extremo de la cadena. El uso de uno o más ánodos sacrificiales podrá solucionar el problema de la fragilidad del metal, que ocurre con tiempo en los sistemas de anclaje a causa de los efectos de la corrosión eléctrica. En el Pacífico resultó infactible mantener boyas en el agua por períodos superiores a dos años, debido a este problema. Los ánodos pueden ser cambiados por buceadores, sin grandes esfuerzos.

En la sección 4 se encuentra una lista de recomendaciones para mejorar el diseño utilizado. En la sección 6 se presenta un nuevo diseño mejorado; el diseño Mark 2.

## TABLE OF CONTENTS

Preparation of this Document . . . . .	i
Abstract . . . . .	ii
Acknowledgements . . . . .	ii
Resumen en Español . . . . .	iv
<b>List of Figures . . . . .</b>	<b>vii</b>
<b>1. Introduction . . . . .</b>	<b>1</b>
<b>2. Design and Construction of FADs . . . . .</b>	<b>2</b>
2.1 Surface Buoy . . . . .	2
2.2 The Anchor . . . . .	3
2.3 Mooring System . . . . .	4
2.4 Underwater Fish Attractors . . . . .	5
<b>3. Deployment of FADs . . . . .</b>	<b>5</b>
3.1 Physical Oceanographic Parameters . . . . .	5
3.2 Echo-sounder . . . . .	6
3.3 Installation and Maintenance of FADs . . . . .	8
<b>4. Results and Recommended Design Improvements . . . . .</b>	<b>12</b>
<b>5. Discussion . . . . .</b>	<b>14</b>
<b>6. Design for MK2 Buoy . . . . .</b>	<b>18</b>
<b>7. Conclusions . . . . .</b>	<b>20</b>
<b>Figures . . . . .</b>	<b>21</b>
<b>Addendum . . . . .</b>	<b>43</b>
<b>References . . . . .</b>	<b>45</b>



## LIST OF FIGURES

Figure 1	General surface movements of migratory tunas (yellowfin tuna, blackfin tuna, skipjack tuna) in the area around Curaçao. Other pelagic species may follow similar or different routes. . . . .	21
Figure 2	Position of FADs in the south-east area of Curaçao. . . . .	21
Figure 3	Sound velocity/depth calibration curve for waters around Curaçao. . . . .	22
Figure 4	Removable, adjustable and flexible mounting for portable transducer. . . . .	23
Figure 5	Buoy details . . . . .	24
Figure 6	Cross sections of buoy. . . . .	25
Figure 7	Arrangement of attractors on first FAD. . . . .	26
Figure 8	Attractors on second FAD. . . . .	27
Figure 9	Anchor with chain and depth floats. . . . .	28
Figure 10	Design for MK 2 buoy; longitudinal cross-section. . . . .	29
Figure 11a	Detachable top array mk2 buoy (lamp, solar panel and battery box). . . . .	30
Figure 11b	Non-detachable top array . . . . .	30
Figure 12	Simrad EA 300 P portable hydrographic echo-sounder. Transducer mounted in a wooden fish (the fish must be turned 180°, to reduce strain on black pole to which transducer is screwed). . . . .	31
Figure 13	Bracket with big C-clamps which can be clamped to the gunwale of almost any small or medium size vessel. The horizontal pole can be adjusted in length by sliding it forward or backward. It is also able to rotate around its axis. The piece of pipe in the foreground can be fastened to the horizontal pole to hinge vertically downward. The piece of pipe in the background can be used as an extension of the downward pipe when used in somewhat larger vessels..	32

Figure 14	Trial run with bracket installed on 45-ft harbor tug. The restraining rope still has to be tightened since the fish is not yet running vertically. . . . .	32
Figure 15	Underside of anchor. . . . .	33
Figure 16	Anchor boxes before concrete was poured. . . . .	34
Figure 17	Anchor launching ramp with small chain to secure anchor block visible. The stern of the launching vessel, M/V <i>Mermaid</i> , to which this ramp is fastened can be seen in the background. . . . .	35
Figure 18	Anchor sitting on its ramp at the stern of M/V <i>Mermaid</i> . . . . .	36
Figure 19	Launching and retrieving ramp for buoy, with small handwinch. . . .	37
Figure 20	First buoy in the water, south of Hembraak, at the south-east of Curaçao. In this picture the first battery cover can be seen; it can also be seen that there is still too much slack in the wiring. . . . .	38
Figure 21	Chain with heavy swivel ( $3/4$ " , 4 kg) and shackles, the sacrificial anode is visible, fastened around the centrepole. The other swivels used further down are smaller ( $1/2$ "). . . . .	39
Figure 22	The sacrificial anode of the first buoy, 1.5 kg remaining after seven months and ten days of use, in comparison with a new 3-kg sacrificial anode. . . . .	40
Figure 23	MacIntosh fish attractor on second buoy, with stainless steel nose cone attached to end of PVC dampening pole, seen from below. . . . .	41
Figure 24	Two of the three macintosh attractors mounted on their respective PVC dampeners. Plenty of small baitfish present after only 9 days in the water. Picture taken from below looking up. Mooring chain to the left.. . . .	41



## 1. INTRODUCTION

In both Curaçao and Bonaire, artisanal fisheries are fairly well developed. Along the coast small open vessels with outboard engines fish with handlines. These boats are usually between 3-5 meters in length and use engines of 6-25 hp. Since the coastal shelf is very narrow, and the surrounding waters very deep, the nearshore coastal demersal resources are being overfished. A trolling fishery has developed utilising larger vessels (5-10 meters) on the open sea. These vessels, powered by inboard diesel engines of 70-120 hp, are used for pelagic trolling only and are very seaworthy. With these vessels several species of tuna which are locally called "buní" are being caught. These constitute up to about 25% of total fish landings. Other important species are dolphinfish ("dradu") 15%, wahoo ("mulá") 20%, and rainbow runner ("grastèlchi di laman") 10-15%. Total landings for 1990 were estimated to be around 900 mt. The pelagic trolling fisheries are much more productive than the demersal fisheries on the coastal shelf and pelagic species constitute more than 80% of total fish landings.

Since 1979, regular surveys of fishing vessels were conducted by the Department of Agriculture and Fisheries. During the last survey in March 1990, the pelagic trolling fleet was found to consist of 222 vessels of more than 5 meters LOA. Since the coastal shelf demersal resources are already being overfished, fisheries development is aimed at the exploitation of pelagic resources. With a large trolling fleet already in place, and with a local market geared to these products, the deployment of deep water FADs seems to be a logical step towards increased and more efficient production. In Curaçao, pelagic species usually travel from East to West along the island (Figures 1 and 2), and seem to migrate through the area fairly rapidly. The use of FADs near their routes could thus be an effective means to increase captures of these transient species.

It should be emphasized that a large number of people derive either full-time or part-time income from these artisanal fisheries. In addition to the fishermen themselves, other people market the fish. Fishing vessels are built and maintained locally etc. Although the fisheries sector does not contribute significantly to the Gross National Product (GNP), it does have a substantial social impact. In comparison with other sectors of the economy the added product value and labour input in Agriculture and Fisheries in Curaçao are substantial. Thus, a considerable amount of foreign exchange is being saved which otherwise would have had to be spent on food imports. For these reasons efforts to develop the fisheries make economic sense.

As part of its fisheries development program, the Department of Agriculture and Fisheries decided to design and test three deepwater Fish Attraction Devices (FADs). The design would be a precursor to an improved model to be deployed at several sites along the coast on a permanent basis. In view of the fairly high costs of setting buoys in deep waters, it was decided that in this case, a durable design, even though more expensive, would in the end be more cost-effective and appropriate to the situation.



In this report, design considerations and construction details which may be of use to others are emphasized. Where materials were procured or original data were given in imperial units, these are used and metric equivalents are given.

## 2. DESIGN AND CONSTRUCTION OF FADs

The design is based to a large extent on information contained in the South Pacific Commission Handbook No. 24 (1984) "Design improvements to Fish Aggregation Device (FAD) mooring systems in General Use in Pacific Island countries".

### 2.1 Surface Buoy

A spar buoy design was chosen. The buoy was constructed from HOBAS-DUROTEC pipe. These pipes are very strong and have a high impact resistance; normally they are used as sewer lines, pipelines etc. They are centrifugally cast from unsaturated polyester (UP) resin, quartz sand and glass fibers. From a 6 m length of pipe 4 buoys can be constructed, each using 1.5 m of pipe. For the buoys which we have used a 1.4 m section was used (see Discussion).

A pipe with an external diameter of 820 mm was used (Type K). With this diameter one can work on the inside of the buoy during construction. A fiberglass nose cone was added to a 1.4 m pipe section. This nose cone was constructed separately using a mold. A 21 ft (6.4 m) stainless steel 2" (5.08 cm) diameter pipe was used as a centrepole. The nose cone was filled with ballast consisting of polyester resin mixed with quartz sand. The centrepole was attached to the cone and anchored in the resin ballast. The centrepole was also fastened to two wooden cross beams which were inserted inside the HOBAS pipe and securely fastened with fibre cloth. The buoys were filled with polyurethane foam (Figure 6). The stainless steel pipe connects to a galvanized swivel and external ballast (200 kg of chain). For this reason a sacrificial anode is provided. The chain serves as ballast, makes it difficult to steal the buoy and keeps the synthetic rope out of reach of ultraviolet light, which would degrade the material.

On top of the centrepole, above a 30 cm stainless steel radar-reflector, an ML-155 Maxlumina Marine Signal Lantern made by the Tideland Signal Corporation was installed. Power was supplied by a solar panel attached to the centrepole and batteries in the buoy. The connecting cable runs through the centrepole. Cable connectors with O-ring fittings were used to protect the cable where passing through the centrepole wall.

The first buoy was constructed with a 2 m section of HOBAS pipe. After several static tests at sea in order to determine proper balance, using chain as external ballast, the pipe section was reduced to 1.4 m. This was necessary in order to keep the buoy from toppling over or wobbling. The cone has a height of 75 cm.



Total volume is approximately 8700 cc (0.87 m<sup>3</sup>).

The weight of the buoy is as follows:

1.4 m of "Hobas" pipe type K 820 mm	54 kg/m	81
GRP (6 mm) Nose cone		17
GRP (6 mm) Top cover		8.5
Stainless steel centrepole 2", 21 ft (6.4 m)		46
Radar reflector SS		9
Sacrificial anode		3
Polyurethane filling		15
Plywood, wood		20
SS attachment bridle		2
Internal ballast		35
Solar panel and batteries		14.4
Lamp		3.2
		-----
Total		254.1 kg

With an external ballast of about 225 kg (50 m chain x 4.3 kg/m + shackles and swivel), which has a submerged weight of approximately 190 kg, a reserve buoyancy of approximately 426 kg was left.

## 2.2 The Anchor

The weight of the anchor, a one-piece concrete and iron block, was designed to equal twice the reserve buoyancy of the surface buoy. The holding power of a block is about half its (submerged) weight. Even if the buoy were to be dragged below the surface by strong currents the anchor should still hold. On the other hand, the anchor should not be excessively heavy since this will increase handling problems and costs.

The anchors used had a weight of 1260 kg and a volume of about 4000 cc (0.4 m<sup>3</sup>), the submerged weight was about 860 kg, which is approximately twice the reserve buoyancy (the actual weight of the anchor turned out to be 40 kg less than its design weight of 1300 kg).

The anchor is constructed as a box made of steel plates which is filled with concrete. A reinforcement mat was also used (Figures 9 and 16). Should the concrete crack from the impact of the anchor hitting the bottom, the concrete would still be contained in the steel box and the structural integrity of the anchor would be maintained. The bottom side of the anchor is provided with two 2" (5.08 cm) U beams to increase grip on the substrate and to prevent the anchor from sliding along the bottom (Figure 15).

The anchor was deployed using a specially designed release ramp (Figures 17 and 18) which was connected to the stern of a boat. The anchor could be jettisoned by releasing a handle.

### 2.3 Mooring System

A polypropylene mooring system (3 strand, 20 mm) was used. Weights were used to keep the upper lengths of polypropylene from floating to the surface. On the first FAD an intermediate weight of galvanized chain (3 m, diam 14 mm, 13 kg) was used. The submerged weight of this chain is about 11 kg. This is sufficient to compensate for the flotation of at least 2 coils of 220 m, 20 mm polypropylene which have a buoyancy of about 4 kg each (0.018 kg/m). On a FAD using 4 or 5 coils the intermediate weight should be inserted after the first coil of polypropylene, when 6 or more coils are used, after the second coil.

The following mooring system was used for an FAD based on the use of 4 coils of polypropylene rope:

Depth of surface buoy approx	2
Galvanized chain	50
1 coil of polypropylene 1 x 220	220
Intermediate chain 3 m	3
3 coils of polypropylene 3 x 220	660
Bottom chain	8
Height of anchor	1
	-----
Total	944 m

If a scope of 1.25 (between 1.2 and 1.3) is to be kept, this FAD should be moored at a depth of 755 m.

The intermediate weight of the chain and swivel in the polypropylene mooring system would presumably be the weakest link in the system (Boy and Smith 1984). With a nylon/polypropylene mooring system this weak link could have been eliminated, but the nylon is very expensive and would have made an already expensive buoy even more expensive.

On the second FAD several small lead sinkers were used. The first 300 m of polypropylene were weighted down with these sinkers which were evenly spaced along the length of the line. These sinkers had a weight of about 390-440 g each. The submerged weight was about 45-50 g less. One weight was used every 20 m; on 300 m of line 15 sinkers were used. The sinkers were secured with plastic electrical cable fasteners to prevent them from chafing and sliding down the line. Only three swivels



were used. One ( $3/4$ " diam, 4 kg weight) between the buoy and the surface chain, one at the end of this chain and one between the bottom rope and the bottom chain (both somewhat lighter;  $1/2$ "). This way the "weak intermediate link" can presumably be eliminated while avoiding the use of expensive nylon. However, once optimal sites for deployment of the FADs have been identified and other parts of the system have been tested, a second generation buoy could, if necessary, employ a nylon/polypropylene mooring system.

## 2.4 Underwater Fish Attractors

MacIntosh fish attractors were used (Figures 23 and 24), but the plastic nose cones on these fish attractors were changed to stainless steel and a somewhat larger trim float was used. In the first FAD the attractors are mounted on a separate line which is attached to the mainline with a  $1\ 1/2$ " PVC thick-walled tube acting as a dampener; to diminish the transmission of the up and down movements of the mainline to the sideline (Figure 7).

## 3. DEPLOYMENT OF FADs

### 3.1 Physical Oceanographic Parameters

**Currents:** In Curaçao currents are measured by the Curaçao Port Authority at the South coast near the harbor entrance. Current meters are situated at depths of 2 m and 10 m below the surface and are attached to a platform which stands in 12 m of water. A mean current value of 0.5 knots is recorded with maximum values of up to 2.5 knots. However, further out from the coast a mean current of between approximately 1 and 1.5 knots flowing W-NW is usually encountered. This current is known to reach at least 3 knots occasionally.

**Winds and Waves:** An almost constant trade wind blows from the East with slight variations to E-NE or E-SE. The mean wind force is Beaufort 4 with maxima of Beaufort 7 near the island. No accurate data on waves and wavelength are available for the sea areas close to Curaçao. Seas are rather rough with waves north of the island having a mean height of approximately 10 to 12 ft (3 to 3.7 m) and a wave length of about 100 ft (30 m). The South coast is more protected, with waves reaching a maximum of about 8 ft (2.4 m). Wave length is somewhat shorter.

**Sound Velocity:** Sound velocity in sea water is a function of *temperature*, *salinity* and *pressure*. The relation between sound velocity and these parameters is given by Wilson's equation. Sound speed tables based on Wilson's equation can be found in the Handbook of Oceanographic Tables, US Naval Oceanographic Office 1966.



Using data from the National Oceanic Data Center (NODC) oceanographic database at the Scripps Institute of Oceanography, a depth/vertical sound velocity calibration curve for the waters around Curaçao was established (Figure 3).

In these waters, the monthly average surface seawater temperatures will vary from a minimum of 25.4°C in February to a maximum of 28.1°C in September. Salinity at the surface varies between about 35.3 and 36.8‰. The other end of the measuring range lies at a depth of about 1500 m, which is the maximum operating depth of the Simrad EA 300 P sounder (described below) which was used. At this depth conditions will be a fairly uniform 4.15°C with a salinity slightly below 35‰.

Corresponding sound velocities vary from a maximum of about 1545 m/s at the surface to a lower limit of about 1485 m/s at 1500 m. The sound velocities at different depths which have been calculated with Wilson's equation can also be found in the NODC data together with the temperatures and salinities from which they were derived. Since the signal of the sounder has to travel vertically through layers of warmer waters to the target depth and back, the averaged sound velocity (Harmonic mean vertical sound velocity; see Maul and Bishop) in a vertical direction towards a particular target depth will be somewhat higher than the sound velocity at that depth. A calibration curve was made plotting Harmonic mean vertical sound velocities against depth.

Although this curve was calculated for the waters around Curaçao, it should be very similar elsewhere in the open sea for most of the Southern and Central Caribbean with only minor deviations expected (Area 17, Handbook of Oceanographic Tables, except for upwelling areas).

**Bottom Topography:** The sea bottom around Curaçao slopes down very fast; deep waters can be found near to the coast. The nautical maps give depth contours which have been extrapolated from a grid of fairly dispersed readings, and thus cannot be relied upon for the precise positioning of a deepwater FAD. Steep slopes are to be avoided, since the anchor could slide down into the depths taking the buoy with it. If an anchor scope of 1.2 to 1.3 is to be kept, and the FAD is to be moored at a depth of 1000 m, then the anchor should fall within 40 m of this depth. When the depth contours are far apart, which is the case where a broad underwater shelf exists, the use of an echosounder is less critical and the depth could be taken from the map using one's position. In Curaçao, however, this is not the case and, in order to deploy the deepwater buoys, an echosounder which can give fairly accurate readings in deeper waters is needed.

### 3.2 Echo-sounder

The characteristics of such a sounder are: a low frequency transducer with a narrow beam and sensitive electronics to pick up the weak return signal. If used from a small



vessel, the beam angle cannot be too narrow. Smaller vessels roll more strongly and this will prevent the receiver from picking up the narrow return echo.

The lack of a suitable echosounder has delayed the project substantially. At first it was not realised that fish finders, which are normally used in fishing operations, with depths of up to 1000 m indicated on their recorder scales do not in fact give an accurate reading at greater depths and in most cases give no reading at all. Finally, the Simrad EA 300 P portable precision echosounder was obtained with a 49 KHz transducer and an 11 degree angle beam. With this combination, fairly accurate depth readings can be obtained of up to about 1500 m. On a small vessel, however, it is difficult to obtain readings of over 1000 m. A stable platform and calm seas are needed and the vessel has to move very slowly in order to pick up the return signal.

The standard sound velocity setting on the Simrad EA 300 P is 1470 m/s, the sound velocity is adjustable in 2 m/s intervals. From the depth/sound velocity calibration curve it can be seen that some adjustment is indeed necessary to obtain accurate results. In view of the other abundant sources of errors in precisely positioning the FADs it is imprudent to add others that require little effort to eliminate. When operating the sounder the sound velocity was set at the level predicted for vertical travel towards the target depth. If a sounder is used on which the sound velocity cannot be adjusted, the depth readings which are obtained should be corrected taking this into account.

For the 4 coil FAD which was described above the target depth is 755 m. For this depth the Harmonic mean vertical sound velocity in the sea around Curaçao is approx 1502 m/s.

The sound velocity setting on the echosounder should be changed from 1470 to 1502 m/s. If an echosounder is used on which the setting for sound velocity cannot be changed, then a depth reading on the sounder, which corresponds with the real depth of 755 m should be calculated. In this example this would be  $1502/1470 \times 755 = 771$  m.

A wooden fish was made to house the transducer. A special bracket was constructed which can be clamped to the gunwale of almost any vessel. On this bracket a piece of galvanized steel pipe is mounted protruding outward; the pole can rotate around its axis (Figures 4, 13 and 14). It can also be adjusted in length. At the end of this pole another piece of pipe is hinged vertically downward into the water. The wooden fish with the transducer is clamped to this pole. The vertical pole can be lengthened with a piece of extra pipe. This way the transducer can be properly mounted on almost any available vessel (Figure 13). The transducer is made to run about 30 cm (one foot) below the surface. There is an adjustable towing line to the front of the ship. On some vessels it is necessary to attach this towing line to a pole which protrudes sideways from the vessel. The axis of the wooden fish is canted in such a way (with clamps), that there is a slight off-set from the axis of the ship; the fish is made to move slightly away from the vessel. When moving too far outward it is restrained by a piece of rope. When everything is



properly adjusted the fish will run well and will not be affected very much by the roll of the vessel. It is important that the two parallel poles (Figure 4) break the water surface together. This will reduce resistance in the water markedly. Alternatively, an airfoil section could be made out of sheet metal to streamline the pole(s). When not in use the wooden fish can be hinged backward and put on board the vessel. When in transit one can run to/from the measuring site at full speed.

### 3.3 Installation and Maintenance of FADs

Three locations along the SouthEastern coast were chosen in an area where migrating pelagics are known to pass (Figure 2). These locations were also chosen for the more protected environment at the leeward side of the island. The main fishing harbour at Caracasbaai is situated nearby and many fishing vessels regularly operate in this area. A buoy that works loose from its mooring in this area would most likely be driven towards the shore by the current during most of the year and would stand a chance of being recovered.

#### First FAD

The first FAD was deployed on 9 March 1993 using the buoy-first-anchor-last method. This buoy had a 4 coil mooring system; the target depth was 755 m, the sound velocity setting on the depth meter was set at 1502 m/s. Two boats were used. The depth meter, the surface buoy with ballast chain, the underwater appendages and the first coil of polypropylene rope were stored on one vessel; the anchor, three coils of rope and the intermediate 3 m length of chain on the other vessel. When the approximate location for deployment was reached, the first vessel made a zigzag course to survey the area in order to avoid steeply sloping bottom contours. A fairly level area with a depth of approximately 750 m was selected, at a distance of about 2 1/4 nm from the coast. The ballast chain and the underwater appendages were lowered in the water, then the buoy (Buoy No.1) was lowered and the remaining rope attached to 50 m ballast chain was transferred to the other vessel. This vessel now paid out the remaining rope moving upstream and then back towards the buoy in a large circle. The anchor was jettisoned at approximately 100 m upstream of the buoy.

Meanwhile the first vessel stood off outward of the circle of rope. Actual mooring depth achieved turned out to be 730 m, the actual scope 1.29. The position of the buoy was 12° 0' 10" N, 68° 44 ' 15" W, which is about 2.2 nm off-shore. Ideally the reflecting surfaces of the radar reflector should have made a 45° angle to the vertical. In practice, however, the radar reflector will swing around continuously with the waves, reflecting the incoming beams at various angles. The reflector functioned very well; the buoy could be picked up on radar easily.



The first FAD quickly lost its underwater appendages; the separate line on which these had been mounted was cut, probably by a fishing line. During an inspection trip on 14 April, after a period of rough weather, it was found that the appendages had already disappeared. The battery compartment flooded after about three months. The buoy started to take in water as a result of leakage through the battery box.

The design was changed in the second buoy (Buoy No.2). The cover of the battery box was raised and a thicker slab of plexiglass was used with broader flanges. On 8 August 1993, the first buoy (Buoy No.1) survived fairly rough seas, when hurricane Bret passed about 120 km to the South, along the Venezuelan coast. On 19 October the surface Buoy No.1 was replaced. The new buoy (Buoy No.2) had a 2.5 m length of chain with a large swivel ( $3/4$ "") attached. This chain was fastened to the mooring chain of the old buoy, below the old swivel. Divers released the tension on the chain by attaching a lift bag to the chain at a depth of about 7 m. Subsequently, Buoy No.1 was detached and towed away. This buoy had been in the water for a period of seven months and ten days; the sacrificial anode was spent considerably. Of the original 3 kg only 1.5 kg were left (1.5 kg had corroded away; approximately 200 g/month). The fastening screws of the anode were exposed and this anode could probably not have lasted for more than an extra month before falling off. The mooring shackles and the welds on the stainless steel pole however seemed to be in excellent condition, probably as a result of the effectiveness of the sacrificial anode. Divers attached new underwater appendages. An attractor of the type used by Feigenbaum *et al* in Puerto Rico was also attached.

These new underwater appendages were lost within about 2 to 3 weeks' time. In December, the top light stopped working. During an inspection trip, it was found that the cable to the solar light was broken at the connector to the pole. At the end of January 1994 it was reported that the buoy was floating deeper than normal. An inspection trip was made on 2 February. The current was very strong; the diver could not swim against it. The buoy was fully inclined, and was lying with one top side nearly level with the water. The anchoring chain was completely taut and ran down at an angle. During this inspection it was noticed that the top cover had taken a slightly concave form and was also warped. This could have been caused by excessive strain on the top cover by the centrepole.

The warping of the top cover suggests that lateral forces had been working on the centrepole; this could have been a result of the inclined position of the buoy. The buoy did not seem to be leaking; no leaks could be seen. The battery compartment was not flooded and the buoy was not damaged except for the warping of the top cover. Because of the strong current it was not realised that the buoy had been taking on water. Consequently no effort was made to salvage the buoy. Due to the strength of the current, however, it would not have been possible to cut the buoy loose anyway. The buoy (Buoy No.2) was last seen on 5 February in the afternoon; the next morning it was reported to be missing having lasted only 10 months and 26 days.



It seems likely that the partially flooded buoy was pulled under by the strong currents. Once the buoy is drawn under the drag will increase because of the solar panel, radar reflector and lamp. The buoy would then become fully submersed. The lamp, the battery box and the centrepole would flood first (via the cable connector), followed by the whole buoy. The collapsing depth of the foam would be reached quickly and the buoy would not be able to surface again. On 5 February the buoy could still be seen and nothing unusual was reported. A fisherman later reported having seen the buoy fully awash on 6 February; from his report it is clear that the buoy must have sunk. At the entrance of the harbor a maximum current of 1.5 knots was measured on 4 February and a current of 1.6 knots on 6 February. Currents further out into the sea are stronger and the current at the harbor entrance does not necessarily correlate closely with currents elsewhere along the coast. On previous inspections there had also been fairly strong currents, but on these occasions the buoy had sufficient reserve buoyancy left. The buoy must have been leaking somewhere, most likely via the top cover, which could have been weakened by the increased pull of the centrepole. It is possible that the top cover which was not designed to absorb large strains or lateral strains could have been damaged by a mooring vessel. A somewhat larger vessel, mooring on the buoy, would have exerted undue pressure and/or pull on the top cover. This could also explain the warping of the top cover, which suggests that lateral forces had been working on it. In such a case the top cover would have been damaged and water would have leaked in. It is also possible that there could have been some leakage through cracks in the GRP nose cone or at the seam between the centrepole and the top cover (see Second FAD). Even though the buoy was filled with foam, the reserve buoyancy would have been reduced, thus enabling the strong currents to pull it down.

### Second FAD

The second FAD did not use an intermediate swivel and weight, but small lead weights instead (as described above under section 2.3). This time the buoy and anchor were launched from the same vessel; both were installed on a platform at the stern of the vessel. The depth meter was installed on the second vessel. It was decided to increase the scope somewhat to at least 1.35 m and to moor the buoy in a somewhat less exposed area. Since the intermediate weight had been eliminated, the increase in scope would probably not be problematic. Target depth for this buoy was  $(944-3) / 1.35 = 697$  m and the corresponding sound velocity setting 1504 m/s. The buoy (Buoy No.3) was launched on 21 April 1994. The current was very strong, at least 1.5 knots (1.3 knots at harbour entrance). Actual depth achieved was between 680 m and 685 m, actual scope 1.375. Its position is  $12^{\circ} 02' 01''$  N,  $68^{\circ} 51' 47''$  W which is about 1.3 nautical miles off-shore; directly South of the entrance to Santa Barbara.

During an inspection trip on 29 April, the underwater appendages were still functioning, but shortly afterward the three MacIntosh attractors were lost, with only the PVC poles on which they had been mounted remaining. The top light stopped burning after about



two weeks and in about a month's time, it became clear that the buoy was taking on water and was leaking somewhere. On 20 May, the surface buoy (Buoy No.3) was replaced by Buoy No.1. The malfunction of the light was caused by a burned-out diode. The buoy had taken on quite some water, but no leaks could be seen. The fiberglass of the buoy was sanded down. During this work the fiberglass was treated with ink to reveal cracks. A small crack was found in the nose cone above the internal ballast. The buoy had also been leaking at the through-hull connections with the centrepole, at the nose cone, and at the top cover. These cracks were invisible at the outside. Outwardly invisible cracks, such as the one found in the nose cone, may be caused by flexing of the fiberglass. The fiberglass should be stiffened and strengthened. The cracks at the connections with the centrepole were more likely caused by the difference in expansion of the stainless steel pole and the GRP. The battery box was completely dry. It now seems probable that Buoy No.2 on the first FAD, must have developed similar cracks. This could have contributed to its sinking. Cracks on the top cover could have been caused by a larger size vessel mooring on the buoy; or the formation of cracks, which had already developed, could have been accelerated by vessels mooring on the buoy.

On 15 July it was reported that the top light, radar reflector and solar panel on the buoy were missing. A weld in the pipe, which had been made on this buoy in order to change the wire to the battery box, had given way. The remaining stump of the centrepole, protruding about a foot above the top cover, was sealed off with polyurethane foam on 15 July. It was decided to rebuild Buoy No.3, and to start testing features to be used in the improved design (Mark II), incorporating the experience gained. The battery box was transferred to the top of the centrepole and a detachable array of solar panel, radar reflector, battery box and batteries (Figure 11a). The radar reflector was made of 0.8 mm S steel plate (1 kg), instead of 3 mm (9 kg); thus reducing its weight by 8 kg. The fiberglass on this buoy was sanded and an extra layer added to the top cover. The through-buoy passages of the centrepole at the top cover and the nose cone were covered with a flexible compound (Figure 10).

The function of this compound (Caulktex) is to absorb differential rates of expansion and contraction of the GRP and the SS centrepole. Caulktex bonds well to both metal and GRP. On 12 August an attempt was made to change Buoy No.1 with Buoy No.3. The strength of the current was moderate, but waves were fairly high. The lift bag was attached and the buoy with the broken centrepole was released from its mooring. While trying to attach the new buoy, this buoy drifted away against the hull of the M/V *Mermaid*, completely smashing the solar panel and battery box. Subsequently it proved to be impossible to detach the detachable top array. Consequently the old buoy was reattached to the mooring, and the new buoy towed back to the harbour.

This accident could have been avoided and was the direct result of a simple mistake. The weather conditions were unfavorable, the high waves being even more of a hindrance than the current, which had been stronger on previous occasions when the task of changing buoys had been accomplished successfully (see Discussion). Nevertheless, the



fact remains that it is fairly difficult to change buoys at sea and an accident like this was bound to occur at some point. During a second attempt on 11 November the changing of the buoys was successfully accomplished. The weather was calm and previous mistakes were avoided. The shackles and mooring chain proved to be in very good condition, having been in the water from 21 April to 11 November. The anodes with a weight of 6 kg (2 x 3 kg) on Buoy No.1, which had been in the water from 20 May to 11 November had lost about 1 kg (2 x 0.5 kg) of weight each, over a period of approximately  $5 \frac{3}{4}$  months (approximately 174 g / month).

The second FAD has now outlasted the first FAD and was still functioning when this article was finalized.

### Third FAD

A third FAD is proposed based on experiences with FADs No.1 and 2. The third FAD will use a new improved design surface buoy and a nylon/polypropylene mooring system. Design characteristics are outlined in the following section. The remaining surface buoy of the earlier design will be kept as a reserve buoy.

## **4. RESULTS AND RECOMMENDED DESIGN IMPROVEMENTS**

As a result of the experience gained the following are design improvements which were made or which will be incorporated into later designs:

- i) The cover of the battery box was raised (as in the hatch of a ship), and the plexiglass cover made of a larger, thicker slab of coloured solar resistant plexiglass with broader flanges. The cover is fastened with bolts using butterfly nuts.
- ii) An extra 3-kg sacrificial anode was added.
- iii) A different design was used for the underwater appendages (Figure 8). Three MacIntosh fish attractors were fastened on poles made of polypropylene 2" tubes of about 8 ft (2.40 m) in length. These poles were closed at the ends and fastened to the mainline chain with small lengths of chain. The uppermost appendage was attached somewhat deeper at a depth of about 7 m. These appendages will not be launched with the buoy, but fastened by divers to small chains which are welded to the main chain via a metal ring.
- iv) The cable coming out of the pole was moved upward between the bracket holding the solar panel. In this way, it cannot be severed by a mooring cable sliding upward along the pole. The connector which connects the cable coming from the solar panel



to the cable coming out of the centrepole can now be fastened to the bracket and will not flutter in the wind.

Changes i to iv were incorporated in Buoy No.2 and the drawings in Figures 5 and 6.

In a new design (Mark 2), the following changes and/or recommendations should be taken into account.

- v) The reserve buoyancy of the buoys should be increased somewhat. On days with high waves and strong currents the remaining reserve buoyancy seemed insufficient. The reserve buoyancy can be increased by a small increase in volume. The pipe section of the buoy would be increased from 1.4 to 1.5 m and a more pointed cone section would be used (1 m instead of 75 cm). Use of a 1.5 m section will still allow four buoys to be made out of one 6 m pipe. The increase in volume will compensate for changes viii and ix.
- vi) The lower centrepole pipe would be lengthened by about 50 cm; this should enable the ballast needed to keep the buoy in an upright position to be reduced somewhat, thus increasing the reserve buoyancy.
- vii) The HOBAS Pipe should be changed to a GRP filament wound pipe (see Discussion).
- viii) Instead of the normal polyurethane foam a (heavier) non-water absorbing high-density polyurethane foam should be used (see Discussion).
- ix) The top cover and nose cone should be strengthened and stiffened. The thickness of the fiberglass should be increased from 3 to 4 layers (from 6 mm to 8 mm) and heavier supporting beams should be used. When factory-made filament-wound fiberglass is used instead of hand lay-up, it is not necessary to increase the thickness. The centrepole should be fastened to the GRP buoy body using a flexible compound such as Caulktex.
- x) The lamp and solar panel should be redesigned in such a way that they can be taken off and replaced for maintenance purposes fairly easily (see Discussion).
- xi) The top weight can be reduced: The radar reflector could be made of somewhat thinner and lighter material (1 mm SS plate instead of 3 mm), saving about 6 kg. An SS pipe with a thinner wall and smaller diameter (1 1/2" instead of 2") can be used for the upper part of the centrepole. This pipe would be welded to the thicker pipe about 1 m above the waterline (Figure 10). These weight reductions will enable the batteries to be stored on top. If it is decided not to have a top light the radar reflector can be built of more sturdy 2 mm SS plate, covered with reflective materials and a lifting and towing ring can be attached on top of it (see Discussion).



- xii) The battery box opening and cover can be reduced in size (covering the same size box). It should be sufficiently large for one battery to slide in at a time.
- xiii) Two small strips could be welded along the length of the centre pole (see Discussion).

In addition to these improvements in design and construction a program of proper monitoring of fish catches, more frequent inspections and timely maintenance is needed. For these purposes a boat will have to be available. There should always be at least one surface buoy kept in reserve.

When launching the buoys two vessels should be used; a launching vessel and a marker vessel. On the launching vessel, a buoy ramp should be used for the buoy. Use of such a ramp will allow for a much safer launch of the buoy; this ramp will also be used to change and retrieve buoys (Figure 19). If a ramp is not used the buoy may wobble and swing around when it is thrown overboard; causing potentially dangerous situations for the operating personnel. The use of a ramp also permits faster launching of the buoy which is important to obtain precise positioning. Both anchor and buoy will be sitting in their respective ramps at the stern of the launching vessel. All lines will be paid out. The vessel with the depth meter will act as the marker vessel and stay put at the correct position where the buoy is to be set. The launching vessel will move about 200 m upstream of the marker vessel and launch the buoy. Both the buoy and the launching vessel will then start to drift toward the marker vessel, the buoy drifting faster; when the buoy reaches the vicinity of the marker vessel the anchor is also launched. In this way, fairly accurate positioning can be achieved even when currents are strong.

During inspection trips the use of a small current meter, which could give an idea of the load on the buoy (depth of waterline) in relation to the strength of the current would be very useful.

## 5. DISCUSSION

For a deepwater FAD, a mooring line with a minimum diameter of 20 mm polypropylene has to be used, not primarily for its strength but to give sufficient protection against fish bite. The diameter of the mooring lines and their length, along with the strength of the prevailing currents, will determine a large part of the total drag and thus also determine the reserve buoyancy, the minimum size of surface buoy needed and the weight of the anchor. Even when informed and prohibited to do so, some boats will always moor to the buoy. The buoy should be able to withstand such illegal moorings to a certain extent. A sizable surface buoy and anchor will be needed.



If we assume that a FAD is moored in water of about 750 to 1100 m depth (4 to 6 coils of polypropylene) then the mooring lines, chain and connectors become the most expensive part of the system. For this reason the surface buoy and anchor have to be of a design that should last at least as long as the mooring lines, chain and connectors. The FADs are designed to last for about two years; with some preventive maintenance of the connectors near the surface, this period could probably be extended. Buoys could also be recovered after 2 or 3 years of use and be reused. In the Pacific area the passage of typhoons has been a major problem, making it difficult to achieve the goal of developing permanent deepwater FADs. Curaçao is situated at the southern limit of the hurricane routes, in an area where hurricanes pass very rarely. In this area, and in other regions where similar conditions exist, it should be possible to develop a second generation deepwater FAD with a lifetime of 3 to 5 years. If these goals could be achieved such a FAD would be economical, and also much more cost-effective than initially less costly systems with a shorter lifetime.

Military buoys exist which have been moored with thick ropes in very deep waters, these have lasted for years in an open ocean environment (Lowell Collier, M.; Myers R.E and Olive, J.C., 1984). This indicates that the goal of a long-lasting deepwater buoy is technically feasible. For these buoys, however, costs were not a major consideration. For a buoy employed for fisheries purposes, a balance between cost and effectiveness has to be found.

With a spar buoy design all the loads can be transmitted via the nose cone to the centrepole (a three chain bridle can be avoided). As a result the loads will not bear upon the upper surface of the buoy. It is also unlikely that the centrepole could work loose and be pulled through the buoy; this has been a problem with flat cylindrical GRP buoys which were employed off Cairns, Australia. The buoy can move up and down in the water and adjust to changing loads more gradually than a flat cylinder buoy. When properly ballasted with chain as external load, the buoys have a very "seakindly" motion. Even in choppy waters, the sparbuoy type float will dampen motions and will not jerk. This was confirmed through observations by divers. The spar buoy was able to withstand periods with very rough seas; we believe that the fact that this type of design was used was a decisive factor in determining the survival of these buoys in the open seas. A disadvantage is that quite some ballast is needed.

It is very important to be able to see the buoy from afar. If the top light and radar reflector are too low, a buoy will be difficult to see even in moderate waves; such a buoy is likely to be overrun by ships. With a sparbuoy the light and radar reflector can easily be put fairly high above the water.

Although the centrepole on the second FAD (Buoy No. 1) was lost due to a defective weld, it was at first believed that the pole had been cut off with a pipe cutter. It is probably advisable to weld one or two small strips along the length of the centrepole above the waterline. This will make it impossible to use a pipe cutter. Use of an iron



handsaw or a torch cutter will of course remain possible but these would be almost impossible to use on the moving buoy.

While it should be possible to service the electrical system during very calm weather (for instance, a change of batteries), in practice these weather conditions occur only very rarely in Curaçao. Whenever the lighting system had to be serviced, the whole buoy had to be changed. It should not be necessary to change the whole buoy in order to simply service the lamp. It is possible to store the batteries in the top so that the whole array of top light, solar panel, radar reflector and batteries can be taken off and replaced for service. These changes were incorporated and tested in the third buoy, which was rebuilt. This test was not successful. It was almost impossible to detach the top array in the weather conditions which prevail in Curaçao. The top array could only be detached in fairly calm waters.

Many of the problems with the buoys were directly or indirectly related to the light. The light, solar panel and batteries are very expensive, and without them the whole FAD would be significantly cheaper. They are relatively vulnerable to rough handling. When the buoys are loaded on the ship and when they are launched into the water, great care has to be taken to avoid smashing the lamp and/or solar reflector against the ship. When buoys are changed great care has to be taken not to submerge the lamp and solar panel; although these are watertight they were not designed to withstand full submersion. If a cheaper lamp is used which uses a battery only, it will then be necessary to replace the battery quite frequently. This will be very costly if the whole buoy has to be changed in order to change the battery.

On the other hand, the range and power of the ML-155 Marine Tideland lamp is not really needed, a cheaper alternative should be considered. The question is whether it makes sense to have a top light at all. The buoy could do without a lamp and have the radar reflector and centrepole covered with reflective materials such as Scotch tape. This will lower the price of the buoys considerably, and will greatly facilitate their handling while launching, changing or retrieving. The battery box cover will not be needed anymore; a weak spot is thus completely eliminated. It would seem best to use buoys with lights only in those areas where the light is really needed, such as areas with a lot of sea traffic. Buoys without a top light but having a radar reflector and reflective materials would be used in areas with less sea traffic.

The centrepole of the surface buoy was made of stainless steel while the ballast chain was made of galvanized steel; it would have been desirable to avoid the use of dissimilar metals. However, had a galvanized steel pole been used, then the zinc coating would have been lost at the welds and these would then have been exposed to corrosion acting on the areas with greatest stress. It was also noted that the zinc coatings on most pipes commercially available in Curaçao are rather thin. In Curaçao no facilities exist for hot galvanized dip coating. For these reasons the use of a stainless steel centrepole was preferred. Sacrificial anodes were found to solve the corrosion problem effectively. Even



if the centrepole and all the connectors can be obtained of galvanized materials, it is probably advisable to use sacrificial anodes; there will always be some galvanic currents which could be neutralized. A similar situation can be found at the anchor where a steel bridle is welded to a galvanized pipe and connected to galvanized chain and swivel. In deeper waters, however, temperatures and therefore corrosion rates are much lower, and a thicker attachment bridle could be used.

The MacIntosh underwater fish attractors were designed to provide a sizeable shelter structure while minimizing drag, and in this respect the design is certainly very effective. The problems experienced with these attractors (which were also experienced by Feigenbaum and others) were probably primarily due to their weak construction. Attempts were made to solve this problem by constructing stainless steel nose cones. Secondly, the nose cone of the attractor should not be tied to the mainline. The nose cone eyelet should always be allowed to slide around the line to which it is attached (as indicated in the instructions by MacIntosh). When the attractor cannot be mounted on the mainline, as will be the case in a deepwater FAD using chain below the surface buoy, it should be attached to a separate sideline. The sideline arrangement turned out to be vulnerable to snagging by fishing lines. It was decided to mount the attractors at the end of air-filled PVC dampening poles, using a bridle that allows some movement of the eyelet (Figures 8 and 23). This arrangement was used on the second buoy. In spite of this, all attractors were lost within three weeks' time. A Feigenbaum type attractor which was used on the first buoy was also lost in record time. In Curaçao there are periods when strong currents prevail, the seas are usually quite rough and waves are relatively short and choppy. A more strongly built MacIntosh type attractor, mounted at the end of a dampening pole, could probably do the job. Since these are not available, plastic fibres which are enmeshed in the mooring chain will be used for future FADs.

The problems that developed with invisible leaks were probably caused by fatigue in the fiberglass; the forces working on the buoys are considerable. Since the buoys had been lying in the sun for a few years before being used, the fiberglass could also have degraded somewhat and weakened by UV solar radiation. The top cover and nose cone should be strengthened and stiffened, and the thickness of the fiberglass should be increased from 3 to 4 layers (from 6 mm to 8 mm), when hand lay-up fiberglass is used, and heavier supporting beams should be used. Special attention should be given to the fastening of the centrepole to the GRP buoy. The difference in expansion rates of GRP materials and steel is large. For this reason a flexible compound has to be used to seal off the through-hull passages of the centrepole.

If a somewhat lighter GRP wound filament is used instead of the heavier HOBAS-DUROTEC pipe, the somewhat lower weight above the water level would be an important advantage. A better weight distribution will be obtained within the buoy, enabling the external ballast to be reduced somewhat. Lengthening the lower centrepole will increase the leverage of the external ballast and may also help to reduce this ballast.



It was originally decided not to use high density polyurethane foam (HDPU). This foam is more expensive and has a heavier weight which would have reduced the reserve buoyancy of the buoys. It was also felt that it would be highly unlikely for the sturdily built buoys to develop leaks. Should a leak develop sufficient time would be available to change it. In retrospect, the decision not to use HDPU turned out to be a wrong decision; on the MK2 buoys HDPU will be used.

In order to properly determine the cost-effectiveness of the buoys it would have been necessary to monitor fish catches around the buoys. Originally it was planned to do echosurveys around the buoys. A fisheries research vessel would have been used. However, this part of the project did not materialize. The very characteristics which make the Simrad portable echosounder suitable for determining the bottom in deep waters make it unsuitable for monitoring fish in surface waters. Another portable echosounder was not available. It was nevertheless clear that the buoys were attracting fish, even during the periods when the underwater appendages were lost. However, the commercial fishermen were fairly reluctant to report how much they themselves caught. Reports were frequently made by some fishermen that others had caught so much fish around the buoy. Reports were also received from members of the yacht club that they had caught fish around the buoy. A frequent complaint was that those arriving first in the morning would take all. Nevertheless, catches were also reported during other parts of the day. In general, fishermen were very enthusiastic about the project and have been requesting more buoys.

Although it is recommended that a spar buoy should always be used and although GRP is the preferred material, a similar FAD-buoy could also be designed from other materials, such as ferro-cement and/or steel, should these turn out to be more appropriate for other areas. Minor modifications to the anchor design and methods of launching as well as further modifications which take into account the strength of the currents, the deployment depth, and the types of local vessels may be required.

## 6. DESIGN FOR MK2 BUOY

The design for the MK 2 buoy (Figures 10 and 11) is based on an 812 mm outer diameter GRP wound filament pipe of 6 mm thickness (KIALITE). The nose cone and a concave top cover are to be manufactured by the KIALITE factory and are also made of filament wound GRP. The main features of this design compared to the previous buoys are a somewhat larger volume, combined with a weight which is only slightly larger, this results in a higher reserve buoyancy. The weight distribution in the floating body of the buoy is improved, resulting in a lower center of gravity. This in turn enables the battery box to be moved upward, out of the floating body, in a detachable array (cq. detachable in calm weather) of solar panel, battery and battery box. The lower centrepole is lengthened 50 cm, and the top light lowered 50 cm. Alternatively this buoy could be made with a radar reflector covered with reflective materials, eliminating the top light.



The design weight for the MK2 buoy is as follows:  
(some of the weights are estimates)

Detachable top array:	
SS thin-walled 1 1/2 " pipe 1.5 m	4.0
Radar reflector SS (1 mm)	3.0
Solar panel, battery box, bracket	5.8
Batteries (2x3)	6.0
Lamp	3.2
	-----
Sub total	22.0

or:

Radar reflector SS (2 mm)	6.0
Lifting ring on top, and reflective materials	3.0
	-----
Sub total	9.0

1.5 m of GRP pipe 812 mm diam, 6 mm (DN-800) 13 kg/m	40.0
GRP (8 mm) Nose cone (DN 800-50)	60.0
GRP (8 mm) Top cover (DN 800)	15.0
GRP connecting laminates	5.0
	-----
Sub total	120.0

Stainless steel centrepole 2", 6 m	42.0
SS strips	
Sacrificial anode (2x)	6.0
Polyurethane filling (HDPU), approx. 1 m <sup>3</sup>	40.0
Wooden beams (4x)	20.0
SS attachment bridle	2.0
Internal ballast	70.0
	-----
Sub total	180.0

	-----	
Total	322.0	kg

The Volume of this buoy is approx. 11,260 cc = 1,126 m<sup>3</sup>. Total weight approx. 322 kg.



Compared to the original buoys this is an increase in volume of 2,560 cc and an increase in weight of approx. 68 kg. The following mooring system will be used:

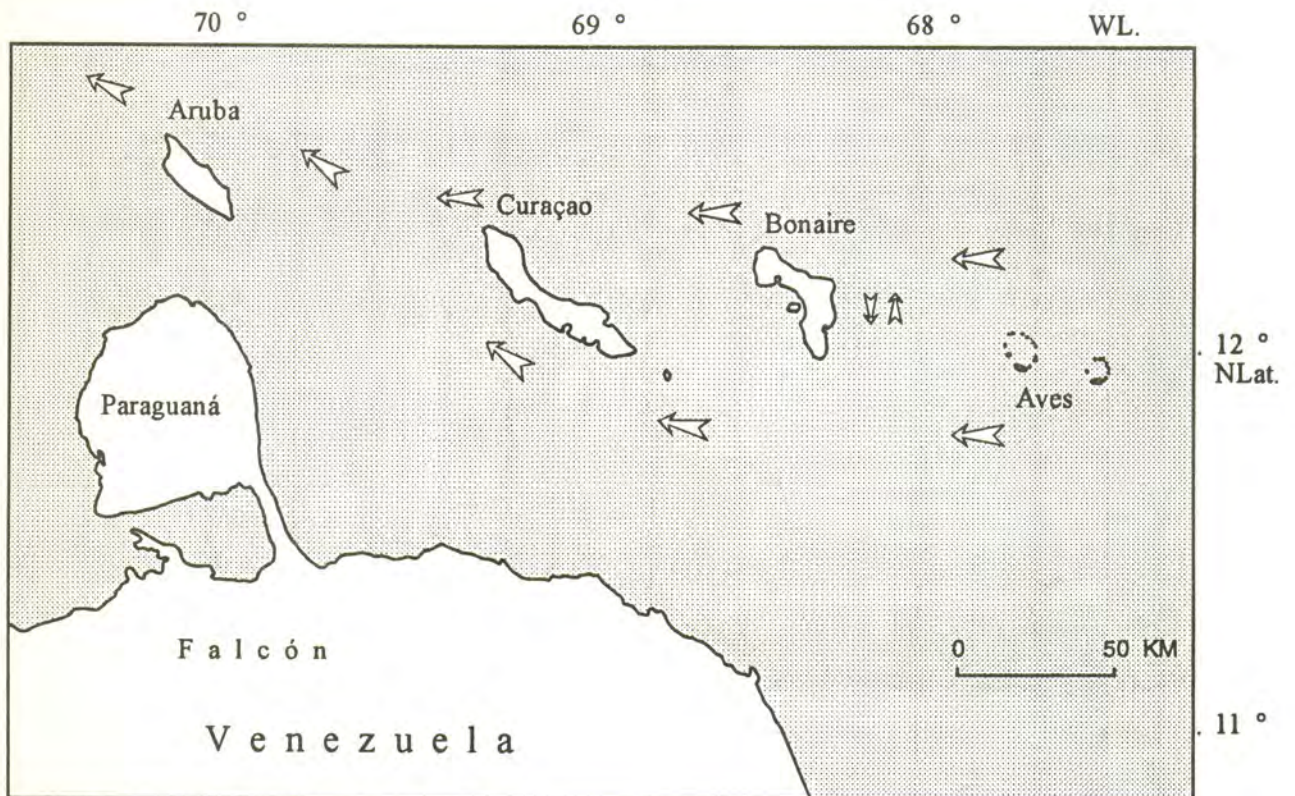
buoy  
 1 shackle 16 mm  
 1 swivel  $\frac{3}{4}$ " (4 kg)  
 1 shackle 16 mm  
 1 steel ring 14 mm or monkey plate (to facilitate buoy changes)  
 1 shackle 14 mm  
 50 m chain 14 mm (215 kg)  
 1 Samson nylite connector ( $\frac{3}{4}$ "- $\frac{13}{16}$ " )  
 1 roll nylon 220 m, 20 mm  
 1 Samson nylite connector ( $\frac{3}{4}$ "- $\frac{13}{16}$ " )  
 1 swivel  $\frac{1}{2}$ "  
 1 Samson nylite connector  
 3 rolls polypropylene 3 x 220 m, 20 mm  
 1 Samson nylite connector ( $\frac{3}{4}$ "- $\frac{13}{16}$ " )  
 1 swivel  $\frac{1}{2}$ "  
 1 shackle 14 mm  
 5 m 14-mm chain with 2 or 3 "Cies" depth floats  
 1 shackle 14 mm  
 1 swivel  $\frac{1}{2}$ "  
 1 shackle 16 mm  
 anchor

With an external ballast of about 225 kg (50 m chain x 4.3 kg/m + shackles and swivel), which has a submerged weight of approximately 190 kg, a reserve buoyancy of approximately 614 kg is left. This represents an increase of about 188 kg (from 426 to 614 kg) compared to the MK 1 buoys. When this buoy is tested, it may turn out possible to reduce the external ballast somewhat to 45 m or 40 m of chain.

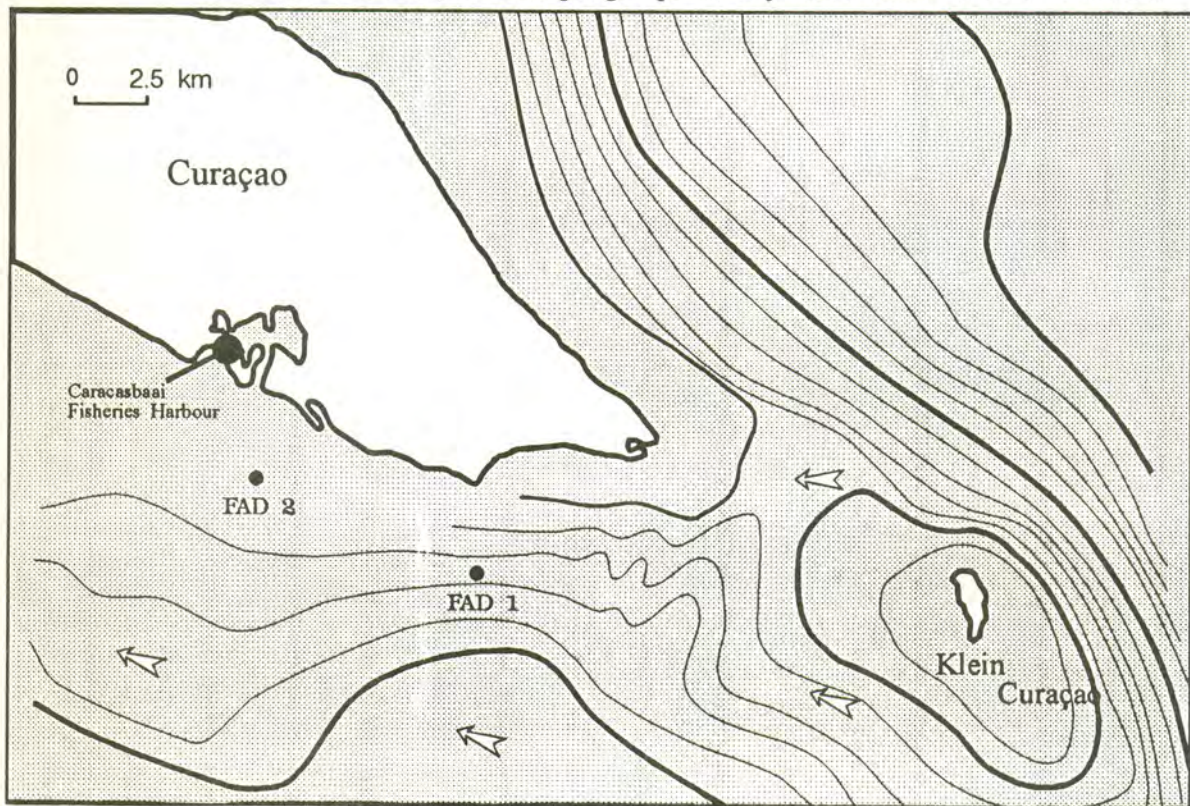
## 7. CONCLUSIONS

Both FADs were attracting fish effectively, and fishermen have been using both. The catches of larger pelagics were better at the site of the first FAD. The second FAD however attracted more baitfish. Around Curaçao the currents can be very strong and waves very choppy. The design has to take this into account; a somewhat larger buoy is needed. The basic spar buoy design functions very well; it is suitable for seas with choppy waves. Some improvements in construction, and various minor design changes are needed. These have been incorporated in a new design for a MK 2 buoy. Further development is needed.





**Figure 1** General surface movements of migratory tunas (yellowfin tuna, blackfin tuna, skipjack tuna) in the area around Curaçao. Other pelagic species may follow similar or different routes.



**Figure 2** Position of FADs in the south-east area of Curaçao.



# SOUND VELOCITY/DEPTH CALIBRATION CURVE

For waters around Curaçao.

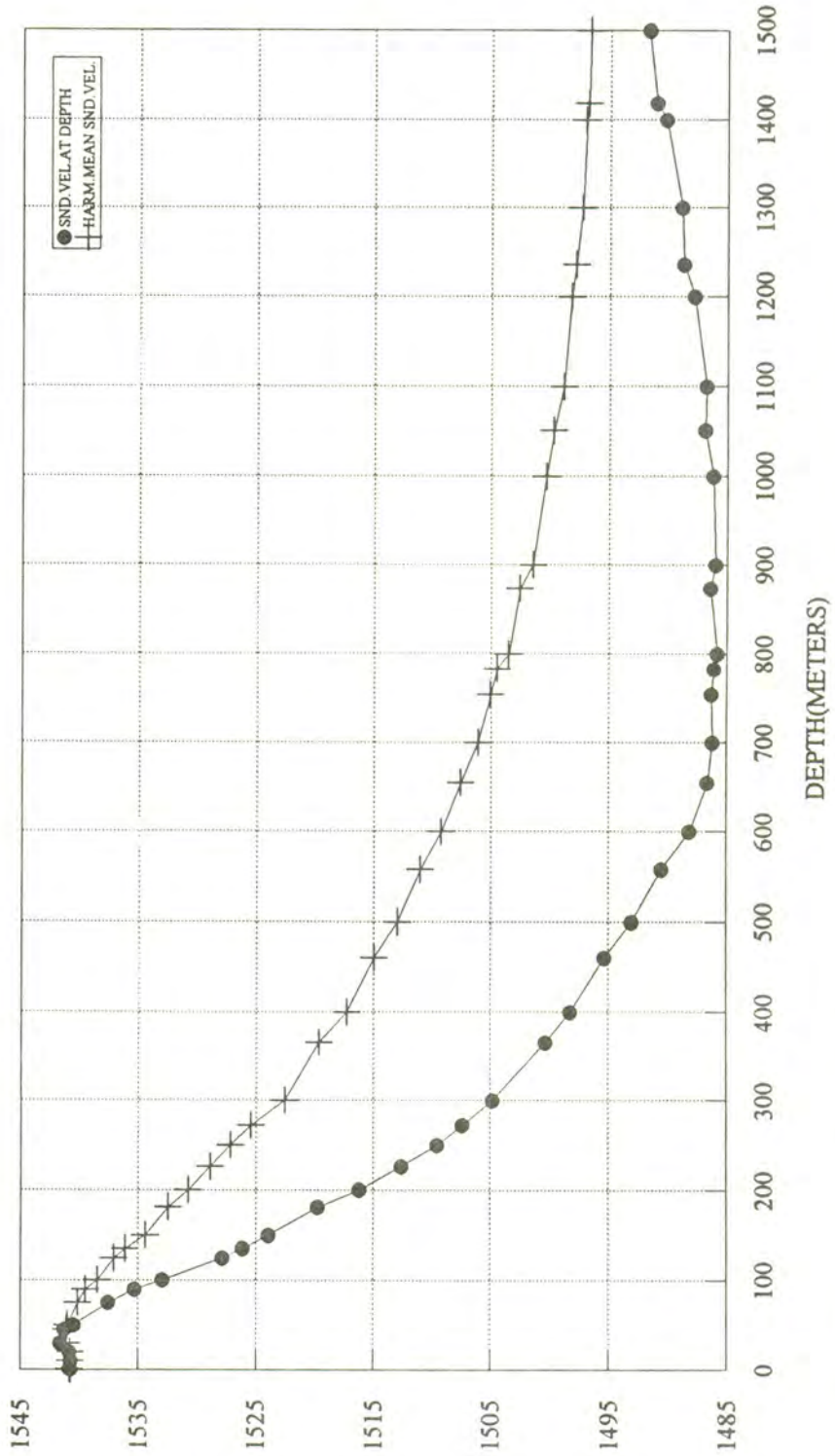
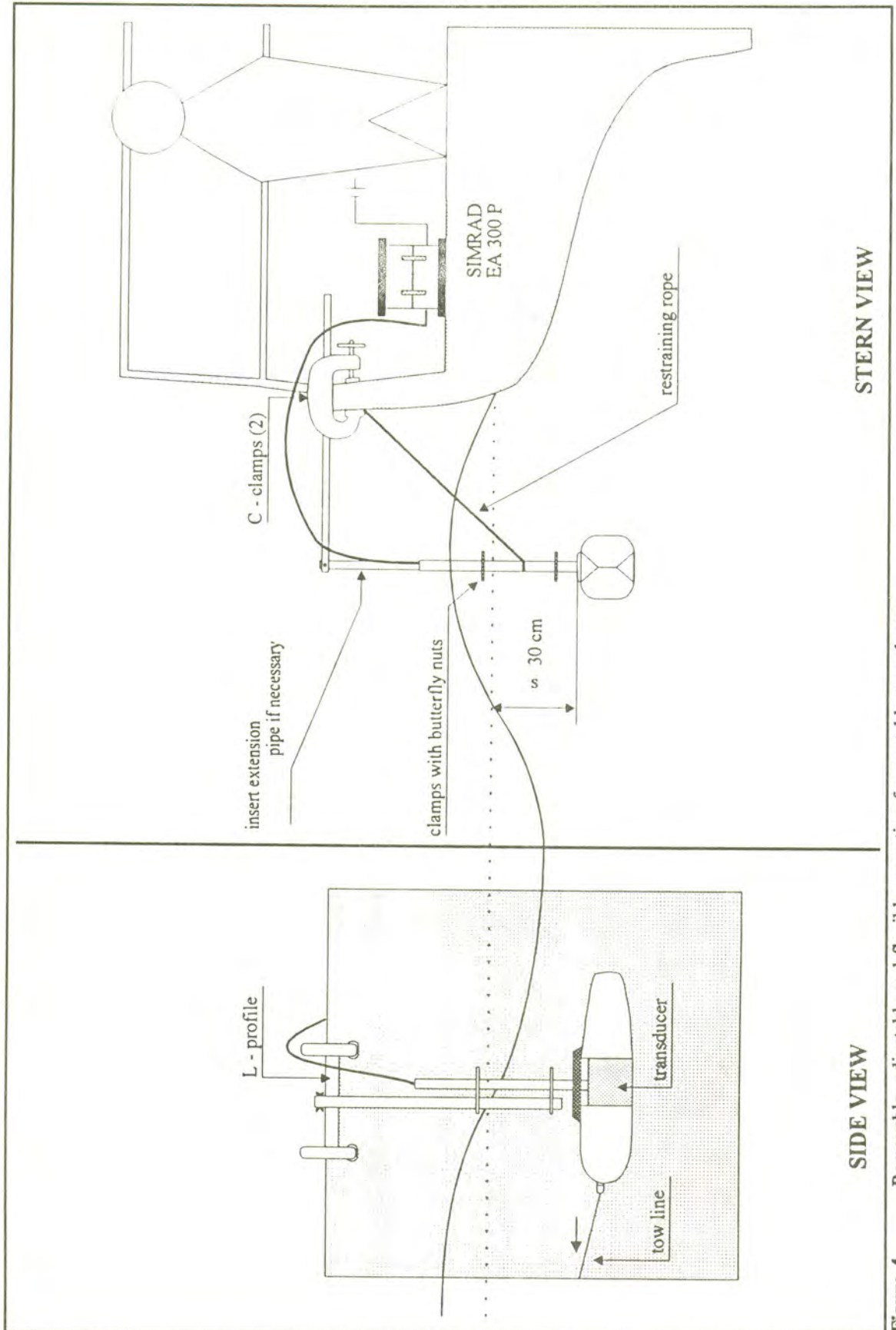


Figure 3 Sound Velocity/Depth Calibration Curve for waters around Curaçao.





STERN VIEW

SIDE VIEW

Figure 4 Removable, adjustable and flexible mounting for portable transducer.



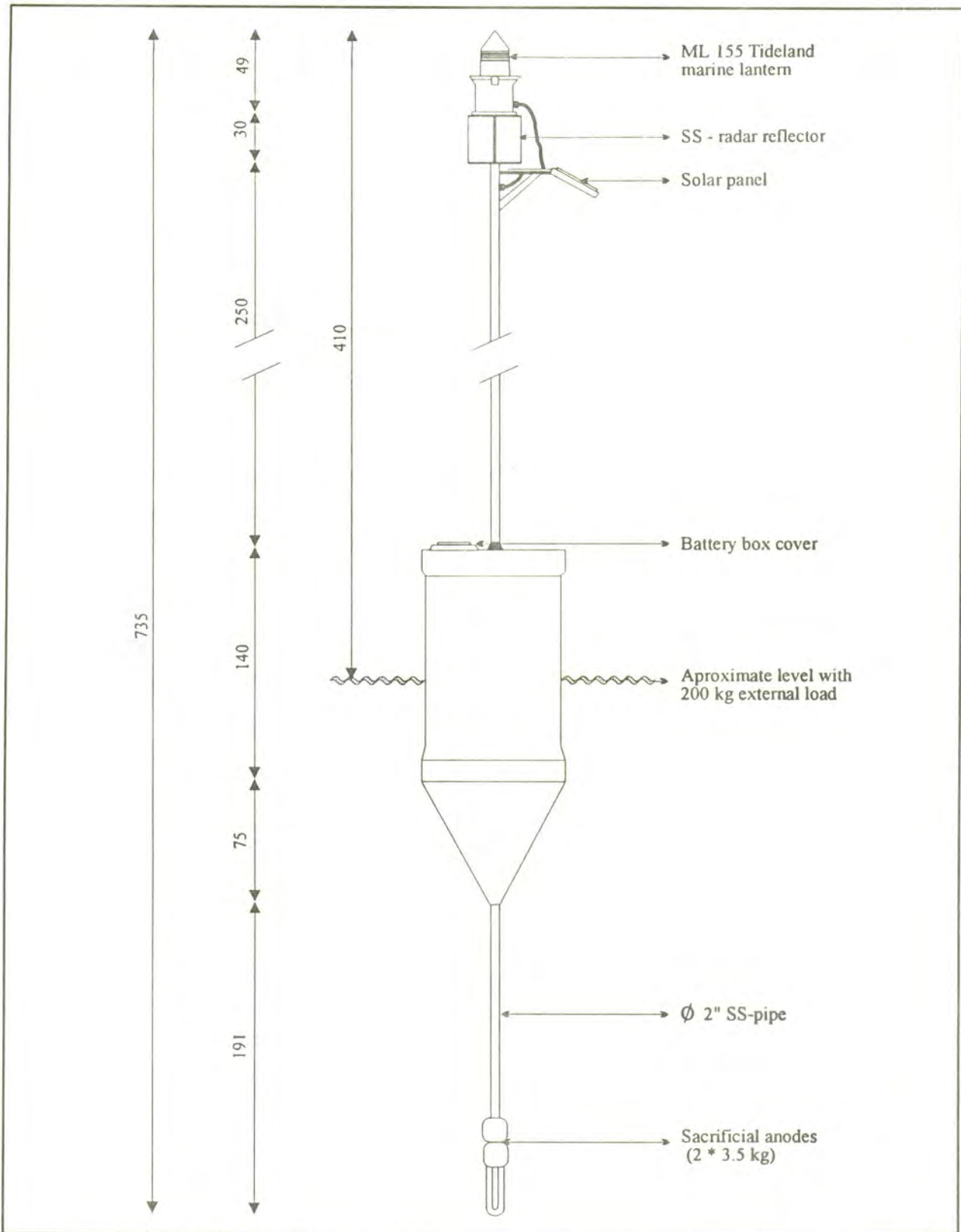


Figure 5 Buoy Details



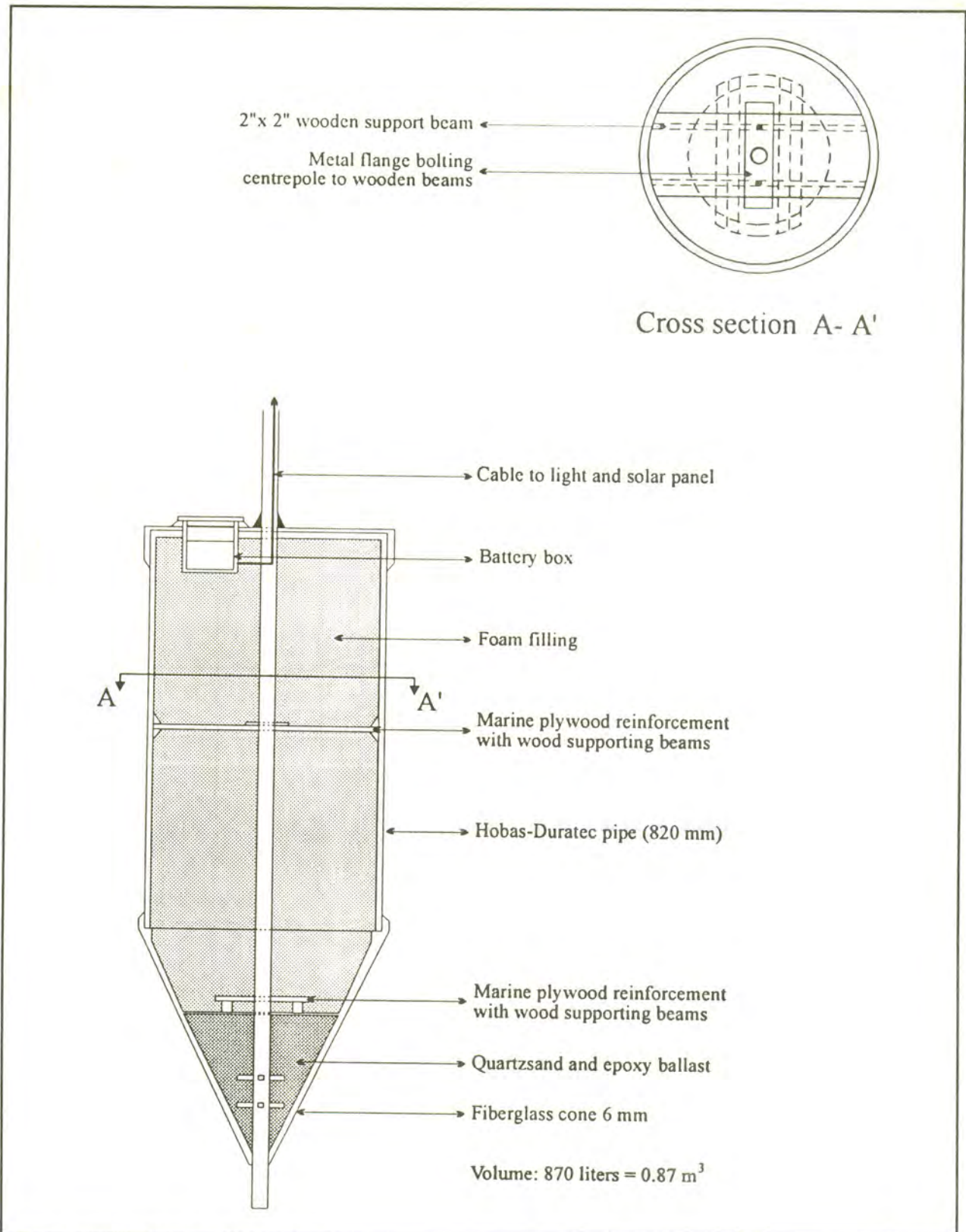


Figure 6 Cross sections of buoy.



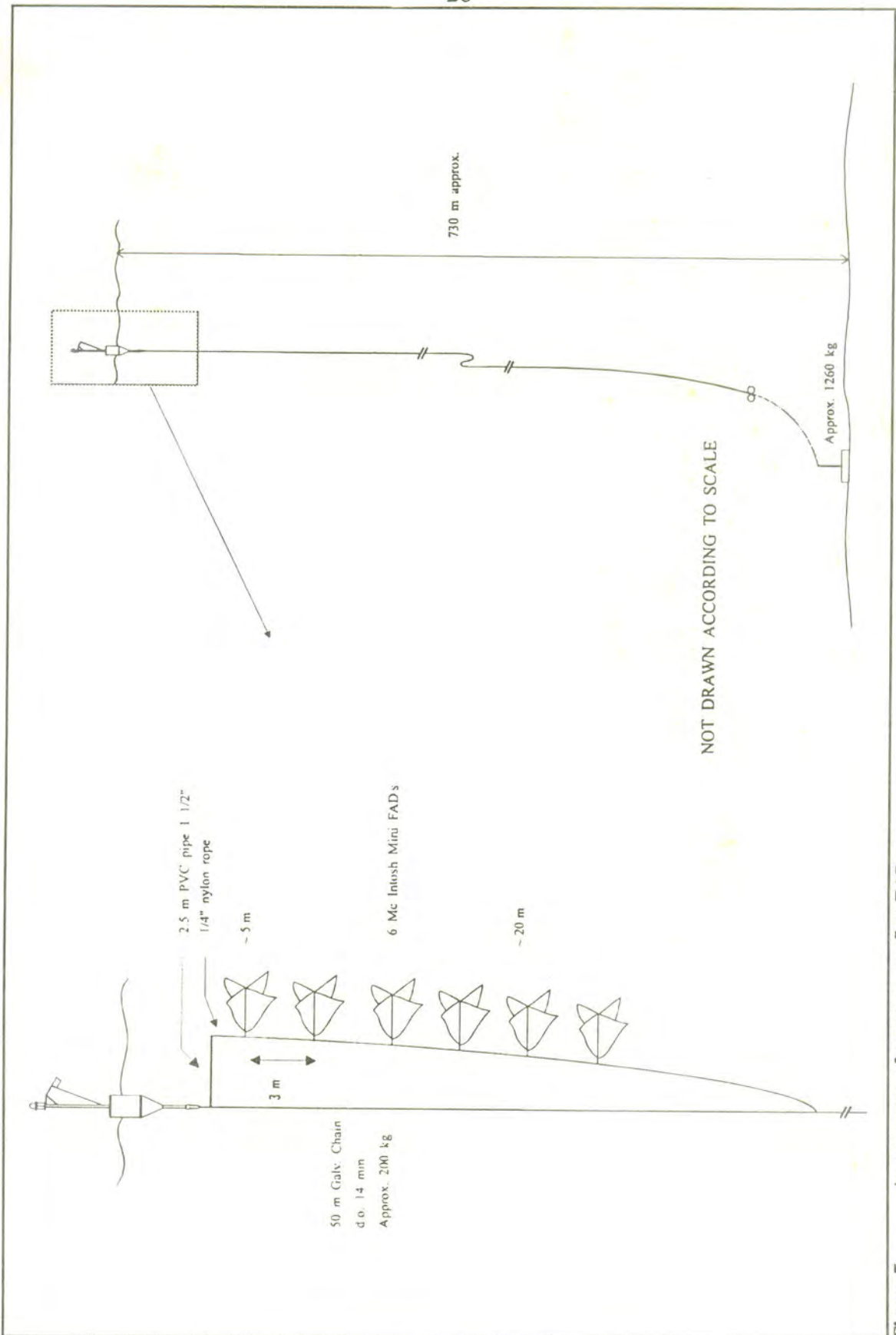


Figure 7 Arrangement of attractors on first FAD.



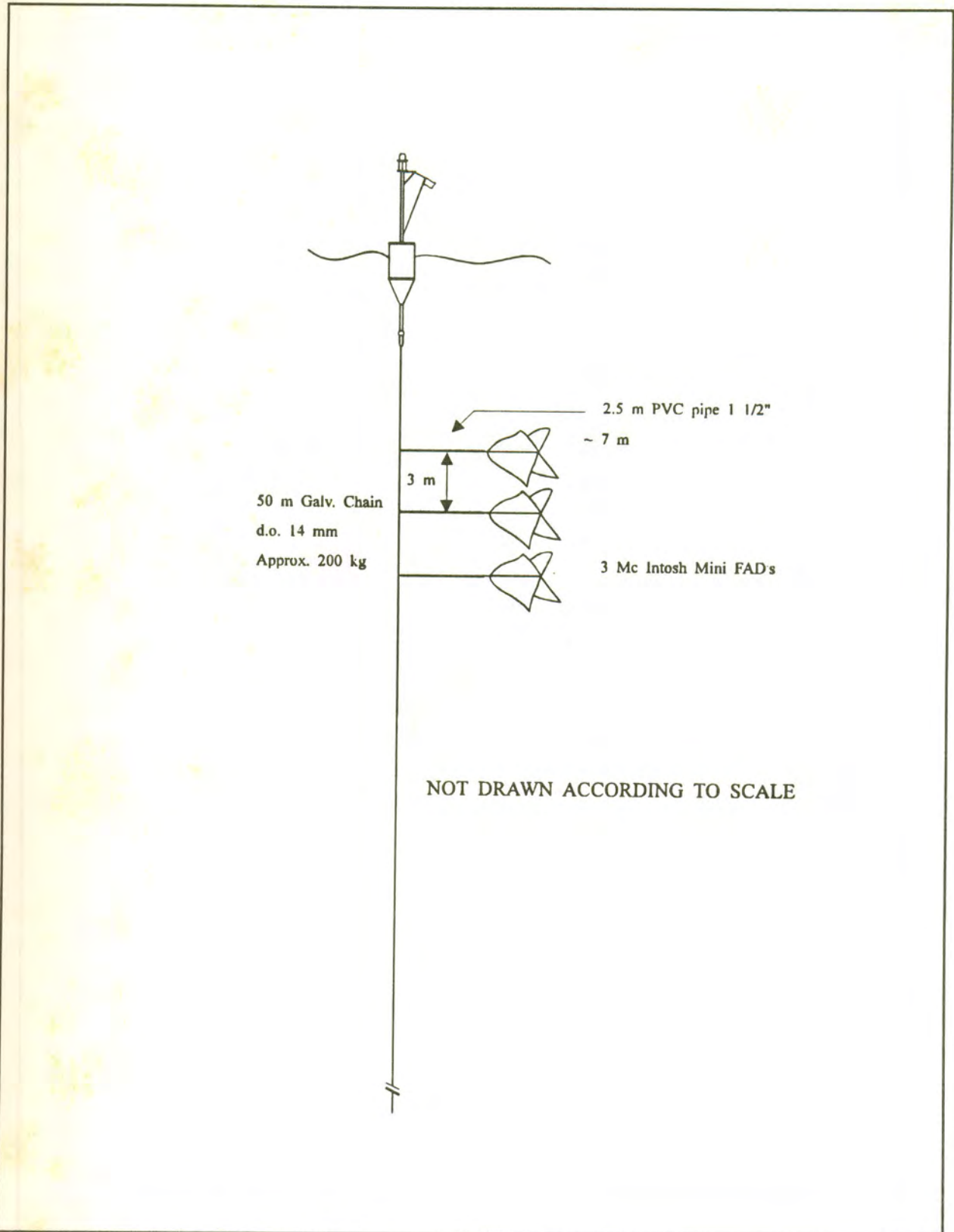


Figure 8 Attractors on second FAD.



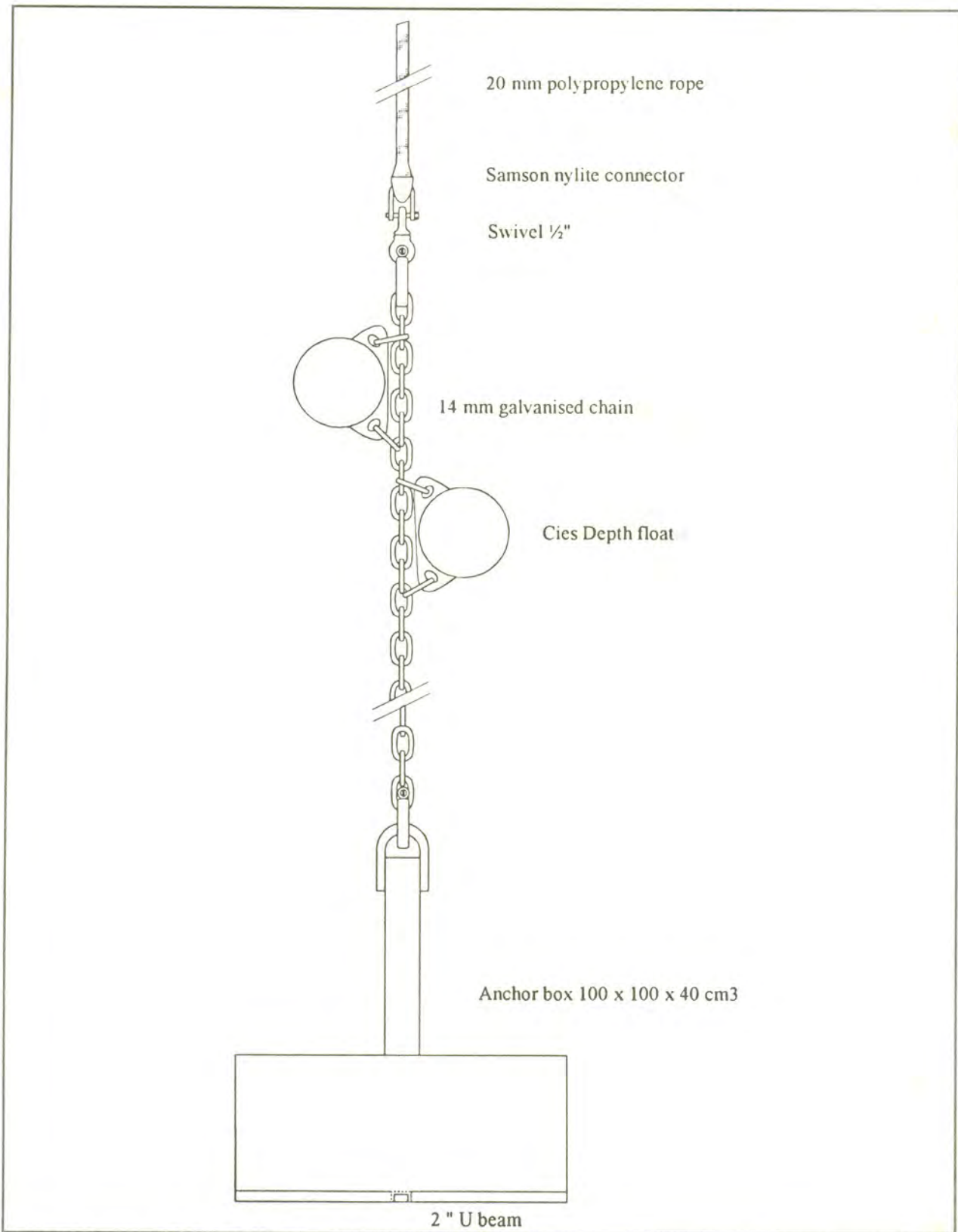


Figure 9 Anchor with chain and depth floats.

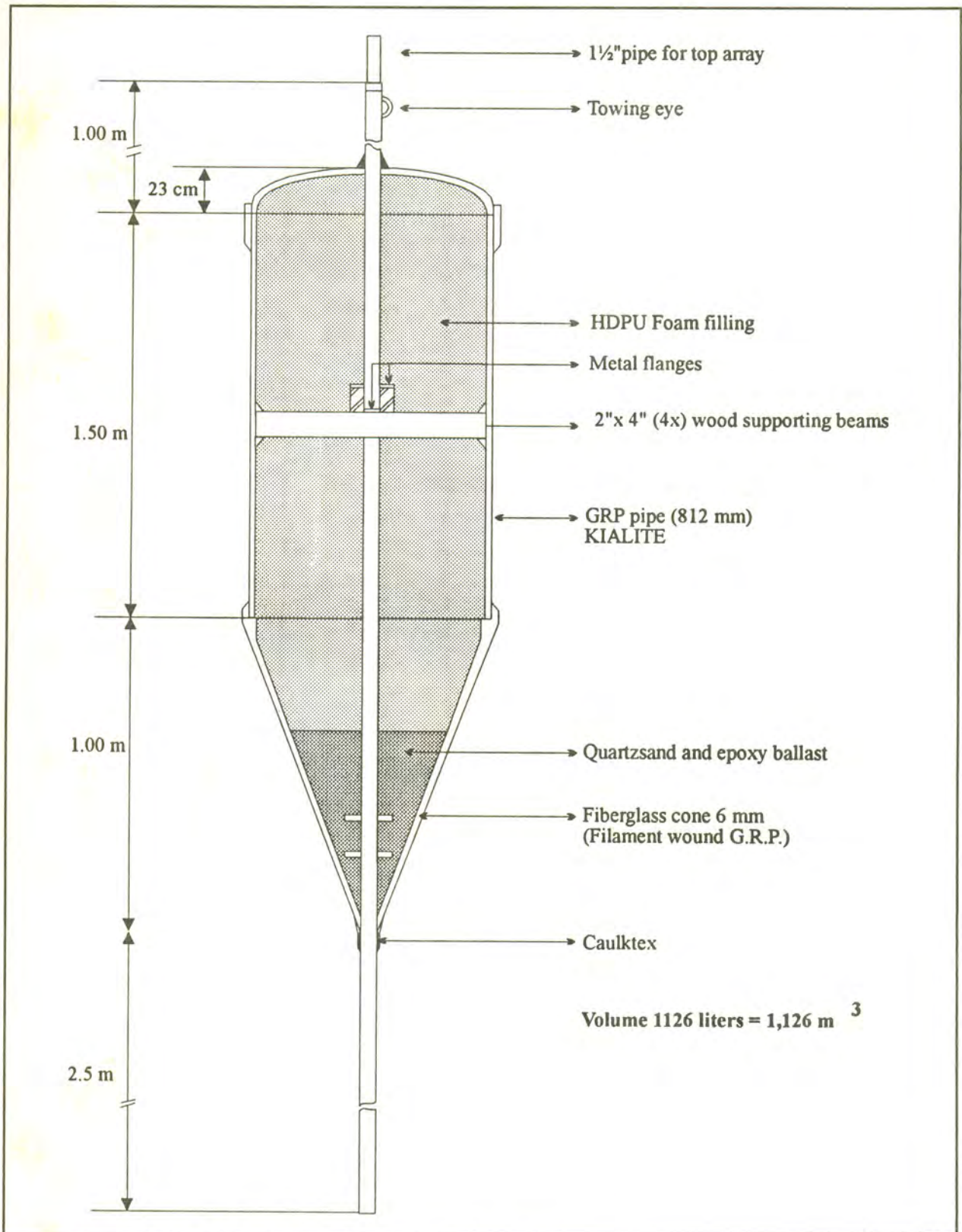


Figure 10 Design for MK 2 buoy; longitudinal cross-section.



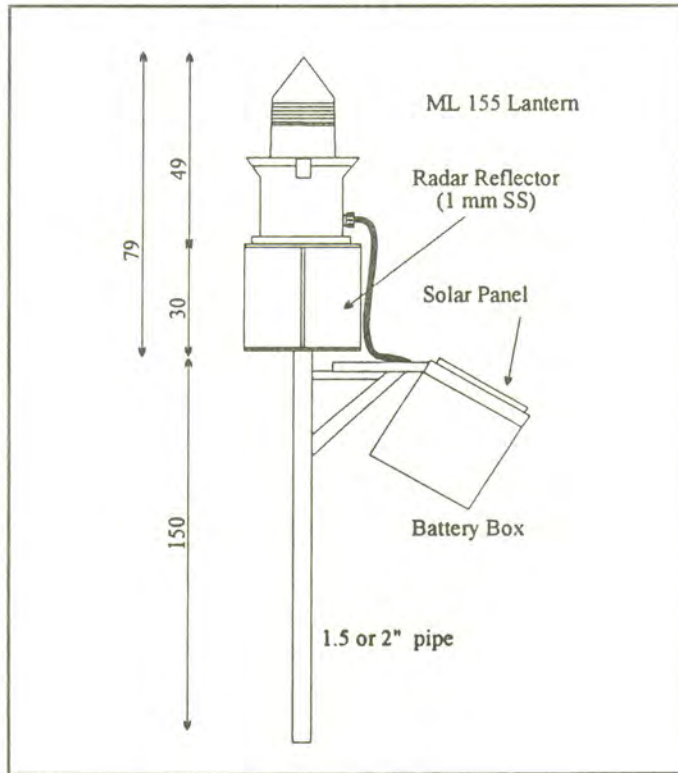


Figure 11a Detachable top array MK2 buoy.

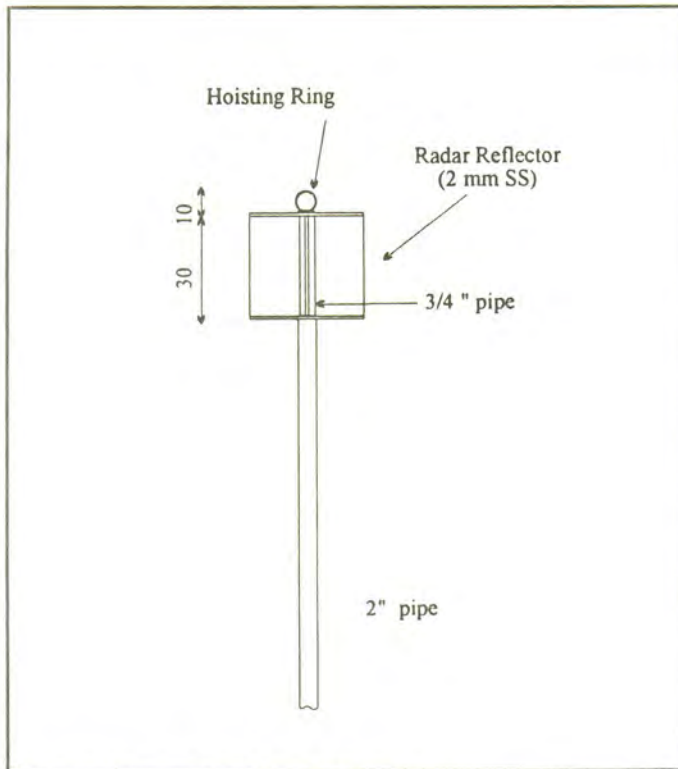
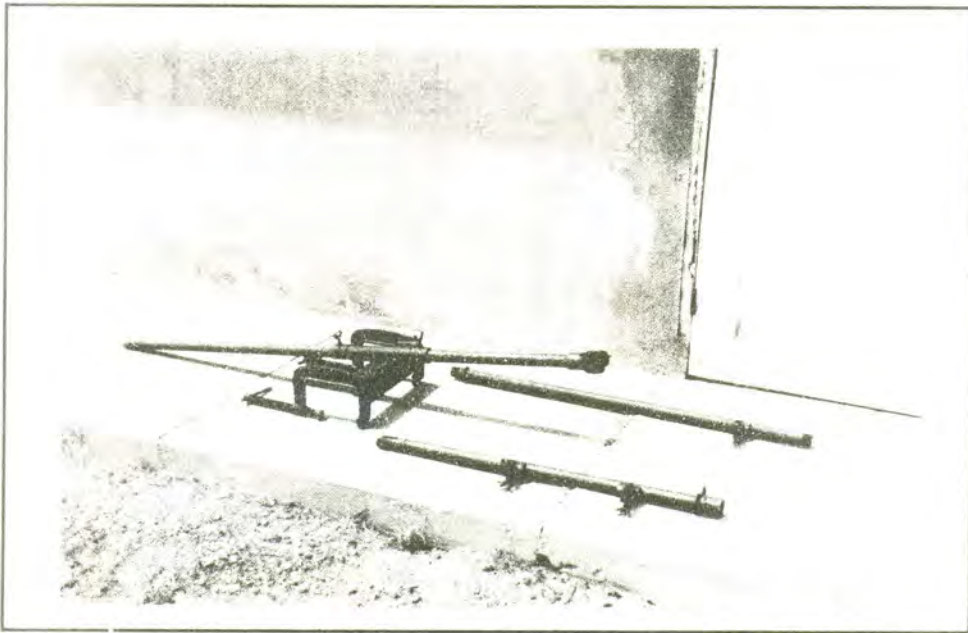


Figure 11b Non-detachable top array.

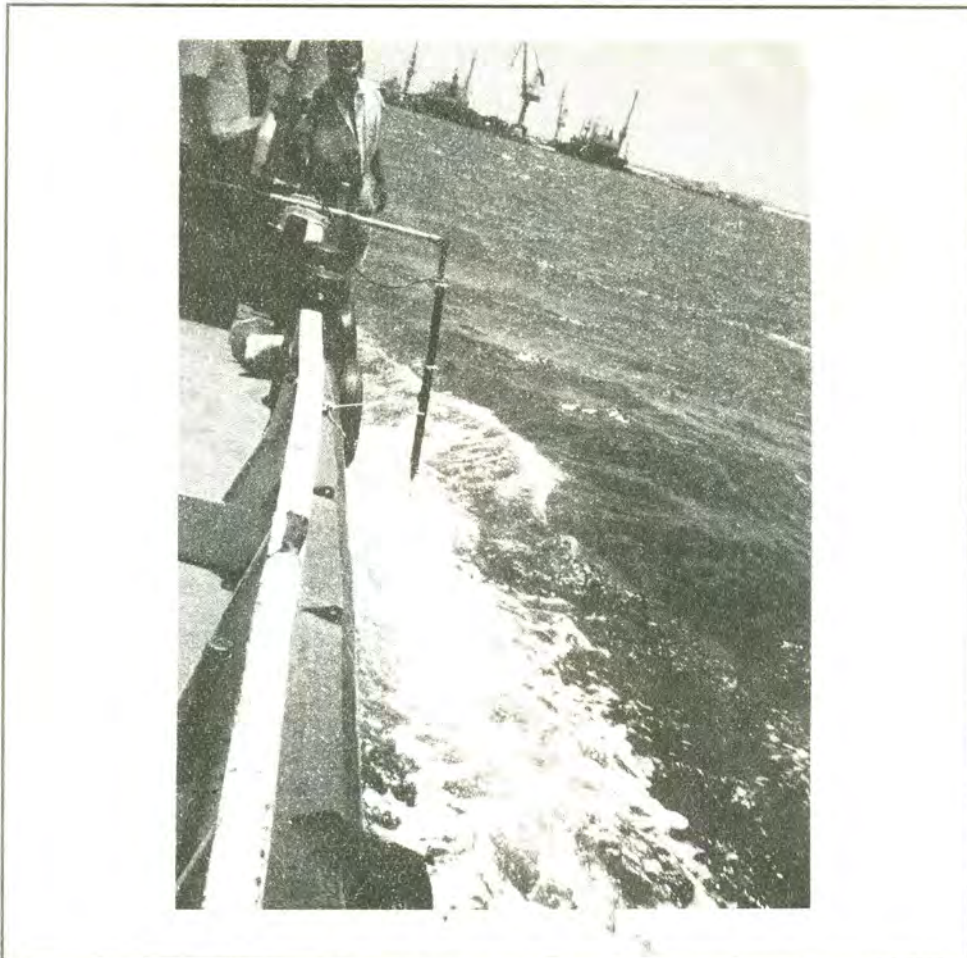


**Figure 12** Simrad EA 300 P portable hydrographic echo-sounder. Transducer mounted in a wooden fish (the fish must be turned 180°, to reduce strain on black pole to which transducer is screwed).





**Figure 13** Bracket with big C-clamps; pole can be adjusted in length and is able to rotate.



**Figure 14** Trial run with bracket installed on 45-ft harbor tug. The restraining rope still has to be tightened since the fish is not yet running vertically.

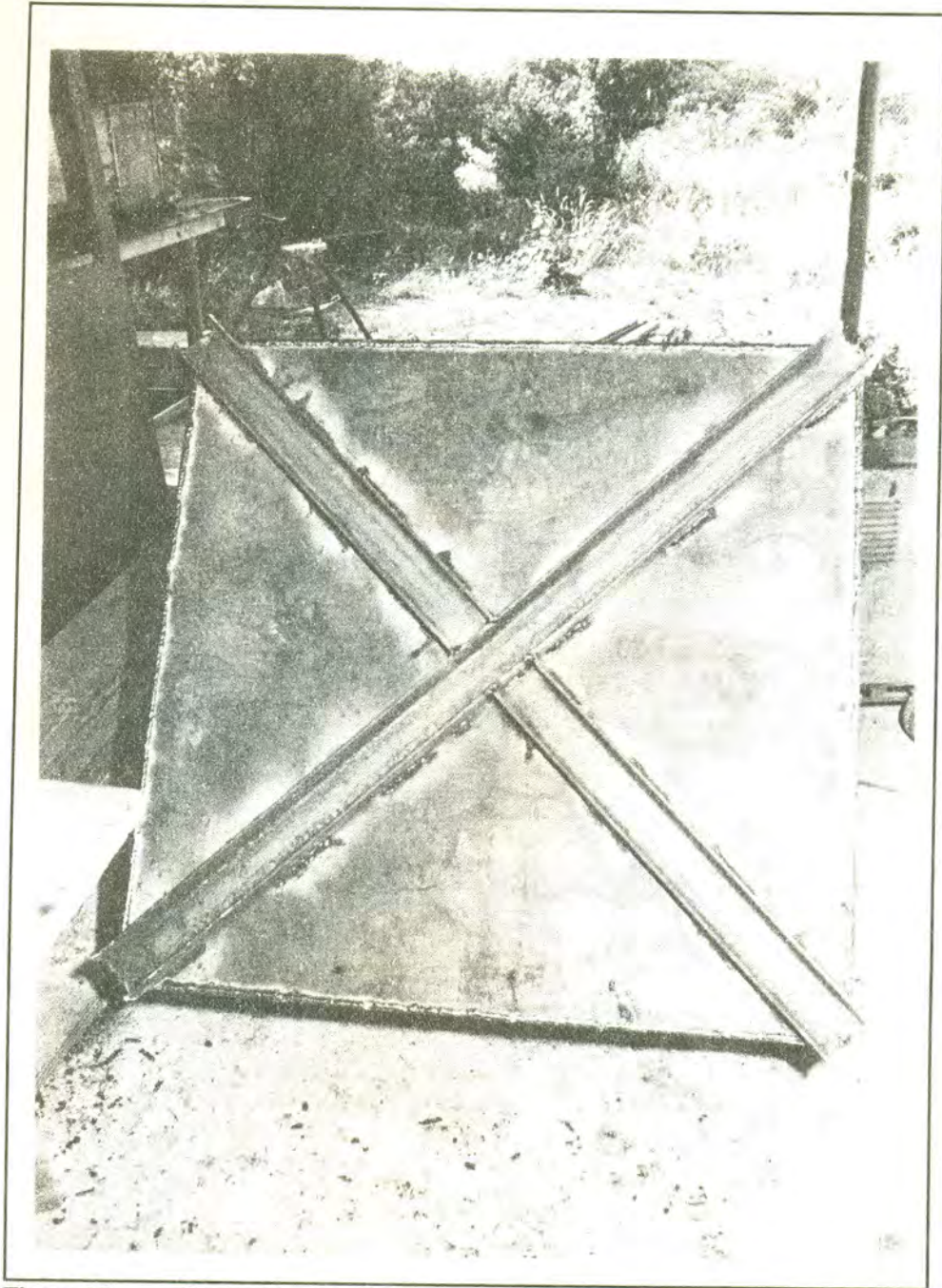


Figure 15      Underside of anchor.



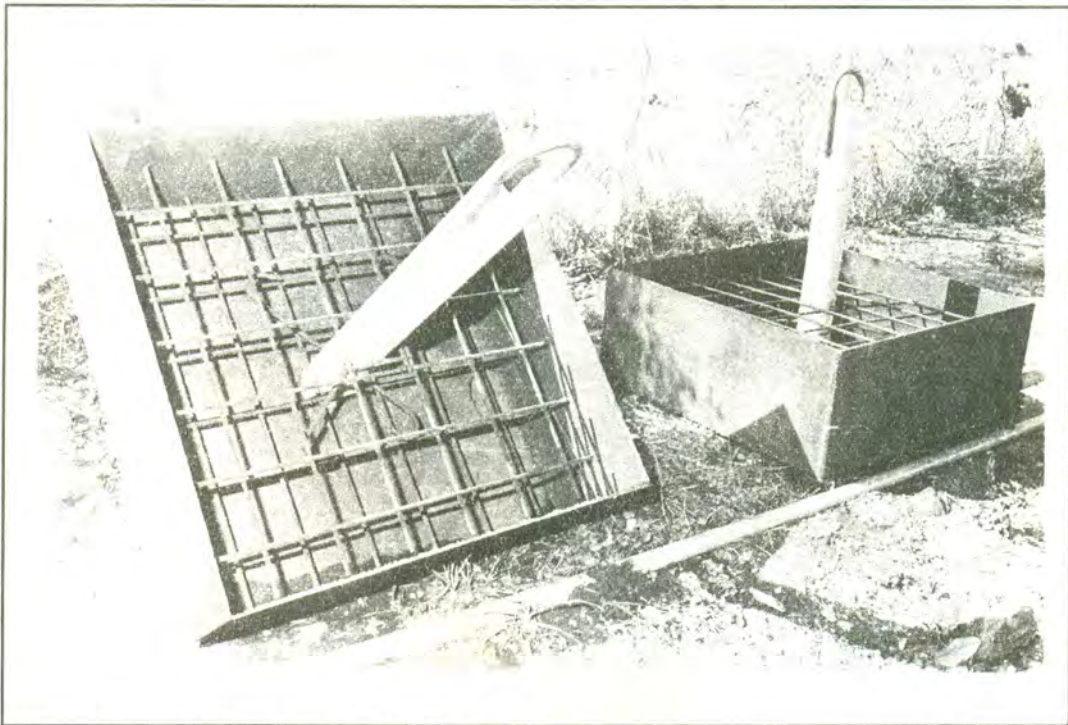


Figure 16 Anchor boxes before concrete was poured.



**Figure 17** Anchor launching ramp with small chain to secure anchor block. Stern of launching vessel, M/V *Mermaid*, to which this ramp is fastened can be seen in the background.





**Figure 18** Anchor sitting on its ramp at the stern of M/V *Mermaid*.

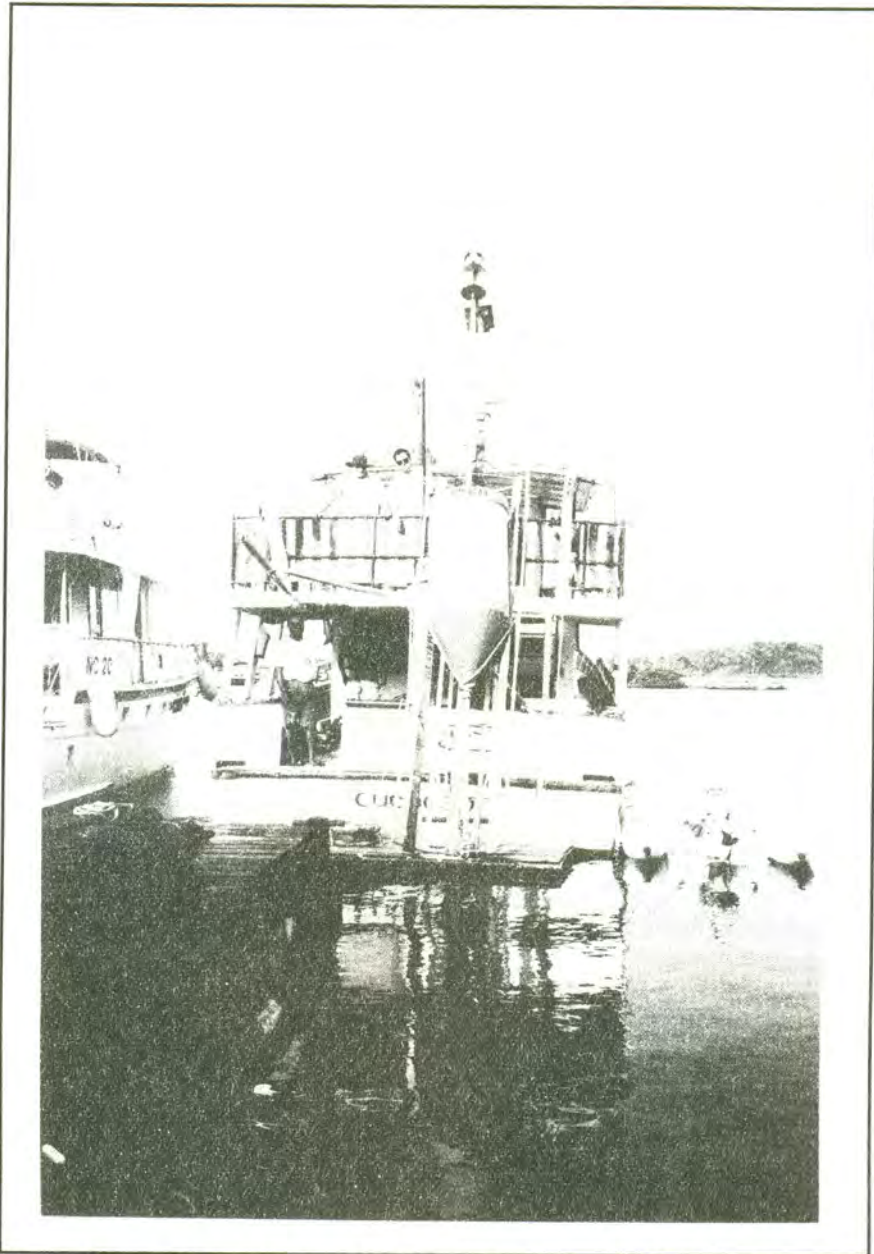
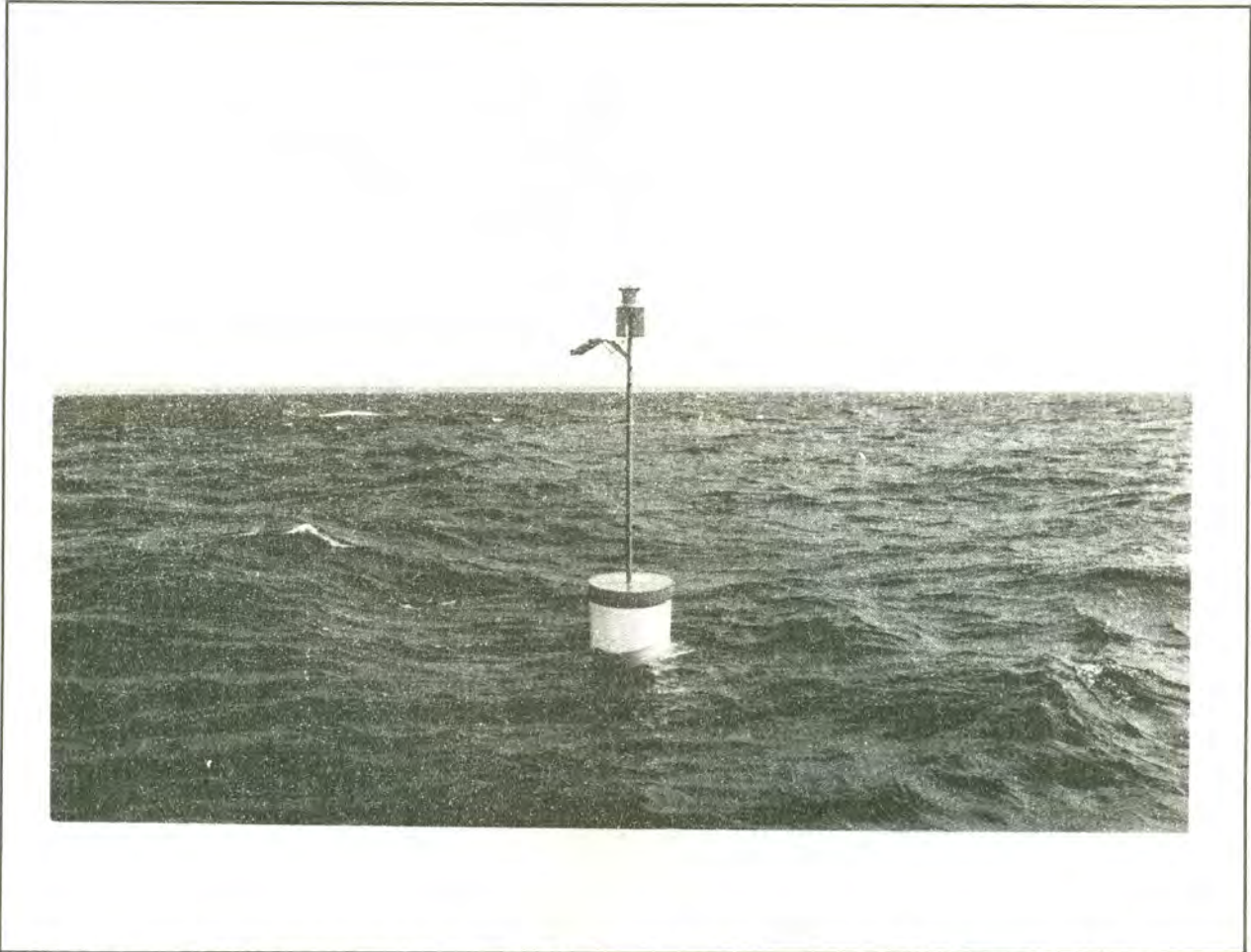
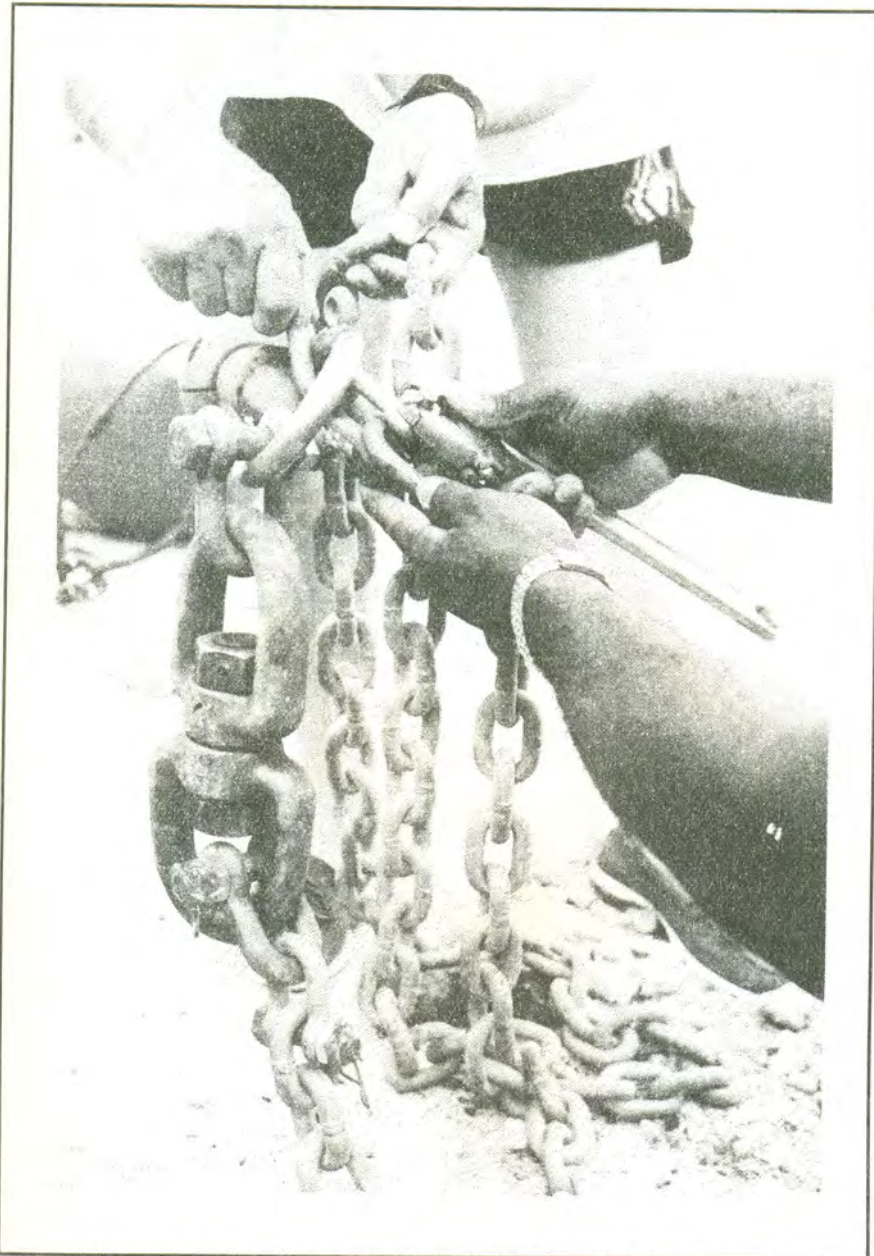


Figure 19 Launching and retrieving ramp for buoy, with small handwinch.



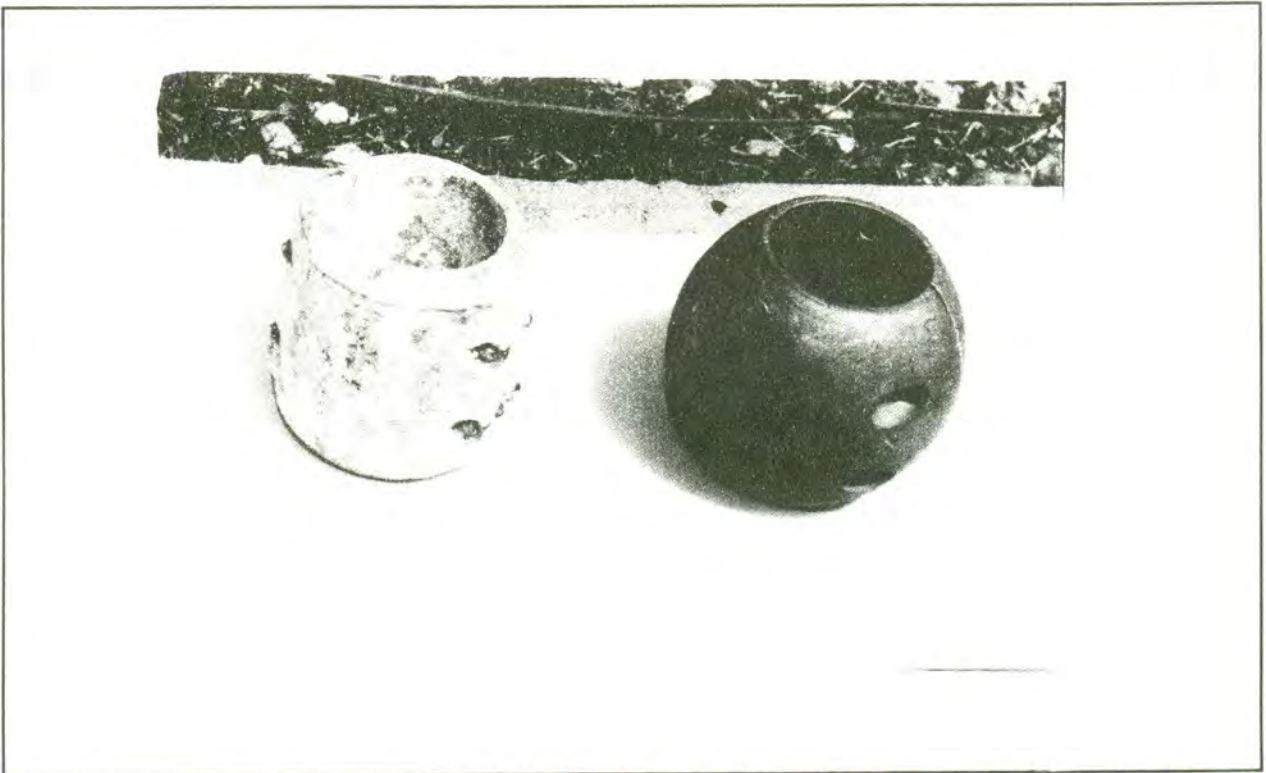


**Figure 20** First buoy in the water, south of Hembraak, at the south-east of Curaçao. Note the first battery cover can be seen; it can also be seen that there is still too much slack in the wiring.



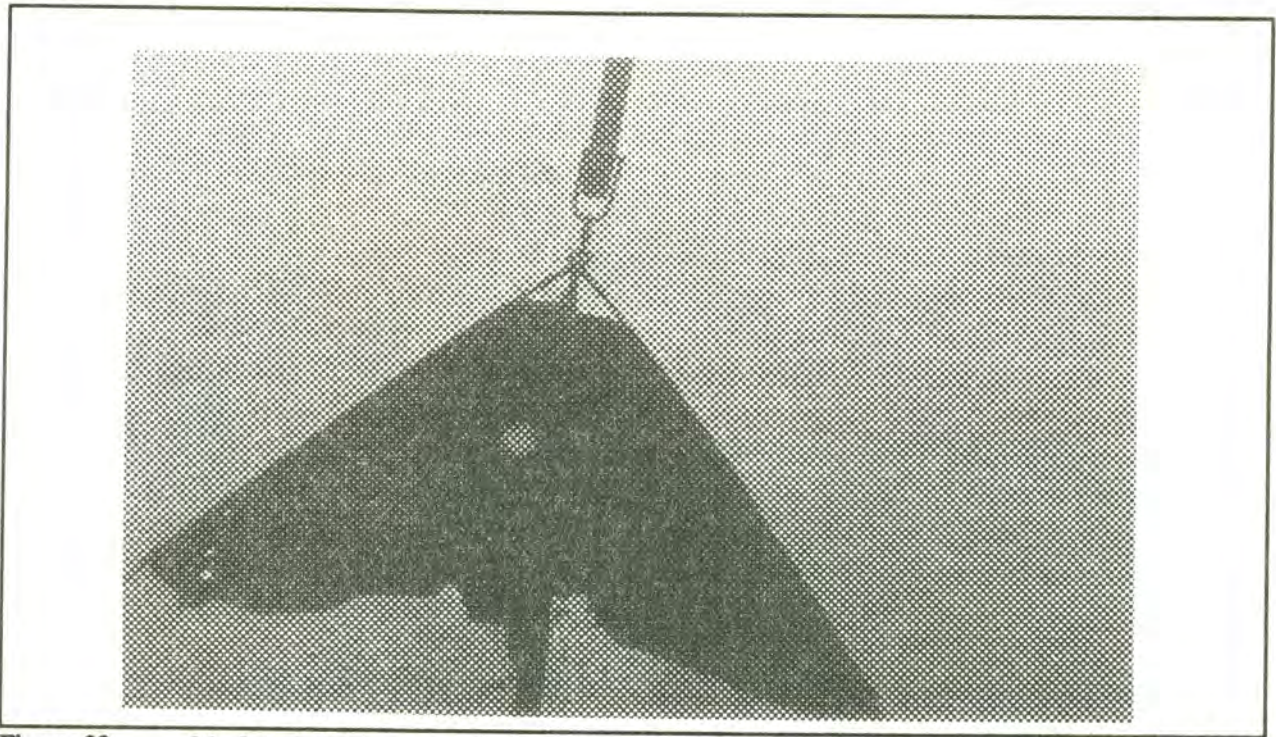
**Figure 21** Chain with swivel and shackles, the sacrificial anode is visible, fastened around the centrepole. The other swivels used further down are smaller.



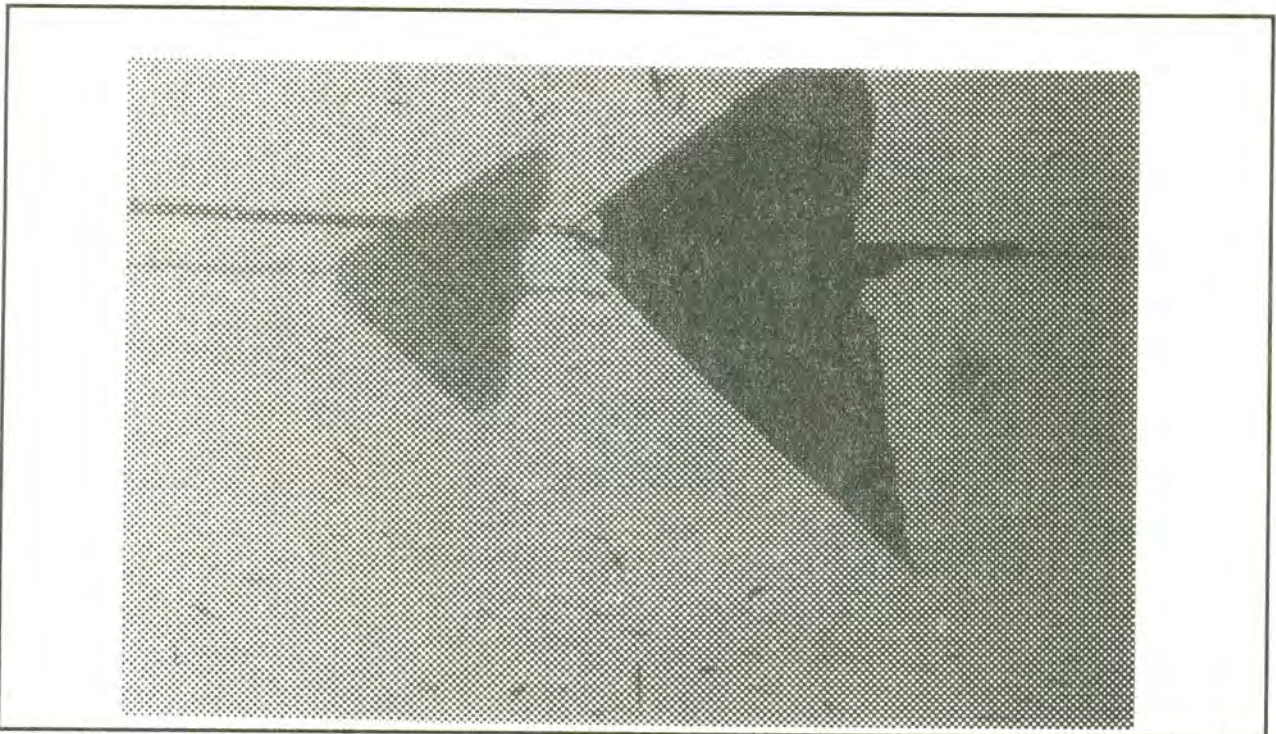


**Figure 22** The sacrificial anode of the first buoy, 1.5 kg remaining after seven months and ten days of use, in comparison with a new 3-kg sacrificial anode.





**Figure 23** MacIntosh fish attractor on second buoy, with stainless steel nose cone attached to end of PVC dampening pole, seen from below.



**Figure 24** Two of the three MacIntosh attractors mounted on their respective PVC dampeners. Plenty small baitfish present after only 9 days in the water. Picture taken from below. Left: mooring chain.



## ADDENDUM

Ongoing monitoring of the FADs continues to reveal new observations, resulting in modified approaches to design and construction.

On 10 August 1995, the buoy (Buoy N° 3) on FAD 2 was again replaced (with Buoy N° 1). The shackles and mooring chain were still in excellent condition as a result of the protection provided by the sacrificial anodes. The buoy had developed cracks at the top cover and at the nose cone, which had clearly been caused by lateral forces working on the buoy. A fairly large vessel must have moored on the buoy. It is now clear the the construction of the new MK2 buoys have now been ordered. The 2" lower centropole in the design will probably be increased to 2½". Some further strengthening of the top cover may also be needed. It seems likely that more (minor) changes will be made, when the MK2 buoys are tested and more experience with these buoys is accumulated.

FAD 2 is still functioning. On 19 August it was again inspected and everything found to be satisfactory. This date marked one year and 120 days since the FAD has been out in the water.

## REFERENCES

- Anon., 1982. Fish Attractors tried off Cairns. Austr. Fisheries. Sept 1982 pg. 14
- Battaglia, A., Lagin, A., Reynal, L., 1991. Implantation de dispositifs concentrateurs de poissons en Martinique. Premiers résultats obtenus et objectifs pour 1991. IFREMER , Martinique.
- Ben Yami, M., 1989. How to make and set FADs (Fish Aggregating Devices). FAO Training Series, no. 15. Versión en Español: Cómo fabricar y fondear los dispositivos para la agregación de peces. Colección FAO: capacitación no. 15, Roma 1990.
- Bergstrom, M., 1983. Review of Experiences with and present knowledge about Fish Aggregating Devices. FAO Bay of Bengal Programme Development of Small-Scale Fisheries BOBP/WP/23.
- Bialek, E.L., 1966. Handbook of Oceanographic Tables. US Naval Oceanographic Office, Washington, D.C.
- Boy, R.L and Smith, B.R., 1984. Design improvements to Fish Aggregation Device (FAD) Mooring Systems in General Use in Pacific Island Countries. South Pacific Commission, Noumea, New Caledonia.
- Feigenbaum, D., Friedlander, A. and Bushing, M., 1989. Determination of the Feasibility of Fish Attracting Devices for Enhancing Fisheries in Puerto Rico. Bull. Mar. Sci. 44(2): 950-959.
- Goodwin, M.H., 1986. Evaluation of Fisheries Enhancement Technology for the Eastern Caribbean. Report to USAID Regional Development Office/Caribbean Grant No 538-000
- Lagin, A., Ledouble, O., Reynal, L. 1993. Les DCP en Guadeloupe, Premières données, IFREMER, Martinique.
- Lowell Collier, M., Myers R.E and Olive, J.C., 1984. Deep Sea Mooring Design, some history and new techniques. David Taylor Naval Ship R&D Center.
- Matsumoto, W.M., Kazama, T.K. and Aasted, D.C., 1981. Anchored fish aggregating devices in Hawaiian waters. Mar. Fish. Rev. 43(9): 1-13.
- Maul, G.A. and Bishop, J.C., 1970. Mean Sounding Velocity. A Brief Review. International Hydrographic Review. ? : 85-92.
- Prindle, B. and Walden, R.G., 1976. Deep-sea Lines Fishbite Manual. NOAA, National Data Buoy Office, Bay St. Louis, MS.